

PowerBOX 3Px PowerBOX 4Kx

MANUAL

FIRMWARE 3.2.6
and later

18.4.2023

Table of Contents

Introduction.....	3
1 Safety notices.....	3
2 General characteristics.....	4
3 Specifications.....	6
3.1 Features.....	7
3.2 Drawings.....	9
3.3 Device description.....	12
3.4 LED and button functions.....	13
3.5 Minimum system requirements (for configuration).....	13
3.6 Package contents.....	14
3.7 Optional accessories.....	14
4 Configuration and control.....	17
4.1 Connecting PowerBOX.....	17
4.2 Detecting and configuring the IP address.....	17
4.3 Static IP.....	18
4.4 Login to device web.....	19
4.5 NETIO Mobile2.....	20
4.6 Restoring factory defaults.....	21
4.7 Controlling the output manually.....	21
5 Web interface.....	22
5.1 Outputs.....	22
5.1.1 Outputs - Energy measurements.....	24
5.1.2 Outputs - General.....	26
5.1.3 Outputs - Schedule.....	28
5.2 Open API: M2M Protocols.....	30
5.2.1 M2M API Protocol - XML over HTTP.....	31
5.2.2 M2M API Protocol - JSON over HTTP.....	37
5.2.3 M2M API Protocol - URL API (http get).....	42
5.2.4 M2M API Protocol - Telnet.....	44
5.2.5 M2M API Protocol - Modbus/TCP.....	49
5.2.6 M2M API Protocol - MQTT-flex.....	54
5.2.7 M2M API Protocol - Netio Push.....	57
5.2.8 M2M API Protocol - SNMP.....	59
5.3 Cloud.....	63
5.4 PAB.....	66
5.5 Watchdogs.....	67
5.6 Rules.....	69
5.7 Users.....	70
5.8 Schedules.....	72
5.9 Settings.....	74
5.9.1 Network Configuration.....	74
5.9.2 Date / Time.....	76
5.9.3 Firmware.....	77
5.9.4 System.....	79
5.10 Log.....	81
6 DECLARATION OF CONFORMITY.....	83
7 Products overview.....	85
8 Product features.....	86

Introduction

Thank you for purchasing this product of NETIO products a.s. Before using your product, please read this **User Manual (MAN)** and the included **Quick Installation Guide (QIG)** to avoid problems with incorrect installation or use.

 **Caution:**

The product works with mains voltage. Mishandling may damage it or result in injury or death.

1 Safety notices

1. The manufacturer is not liable for any damage caused by incorrect use of the device or by operating it in an unsuitable environment.
2. The device is not rated for outdoor use.
3. Do not expose the device to strong vibrations.
4. Unauthorized modifications may damage the device or cause a fire.
5. Protect the device from liquids and excessive temperatures.
6. Make sure the device does not fall.
7. Only electrical appliances approved for use with the electrical network may be connected to the device.
8. Do not connect multiple devices in series.
9. The cable plug must be easily accessible.
10. The device is completely switched off only when unplugged.
11. If the device malfunctions, disconnect it from the electrical outlet and contact your vendor.
12. Do not cover the device.
13. Do not use the device if it appears to be mechanically damaged.
14. Make sure that the input and output cables are rated for the respective current.

2 General characteristics

PowerBOX 3Px

- Switched Power Outputs: 3
- Output Switching: ZVS (Zero Voltage Switching)
- Metered channels: 0

PowerBOX 4Kx

- Switched Power Outputs: 4
- Output Switching: ZCS (Zero Current Switching)
- Metered channels: 4
- Electricity consumption metering: [V, Hz, A, W, Wh, TPF, °]
- Measurement accuracy <1%

Common

- LAN interface 10/100 Mbps (RJ-45)
- Built-in web server for device configuration and control
- Password-protected login into device configuration
- IOC (Independent Output Control)
- PowerUp state - (ON / OFF / LAST)
- Overvoltage protection
- Operating temperature range: -20°C to +65°C
- Supported protocols: DNS, NTP, DHCP, HTTP, uPNP
- Supported M2M protocols: Modbus/TCP, Telnet, SNMP, MQTT-flex, Http Push, XML, JSON, URL API

Overview of PowerBOX 3Px and PowerBOX 4Kx variants according to the electrical socket type

e.g. PowerBOX 4KF use Euro input plug (CEE 7/7) and Type F (Schuko) output sockets

"X"	Variant	Output socket	Input plug	Voltage	Max. current	Max. load
F	DE	Type F	E/F (CEE 7/7)	230V ~	16A	3600W
E	FR	Type E	E/F (CEE 7/7)	230V ~	16A	3600W
G	UK	Type G	Type G	230V ~	13A	3000W

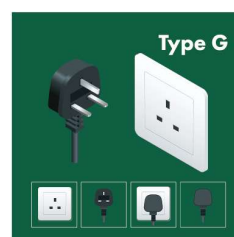

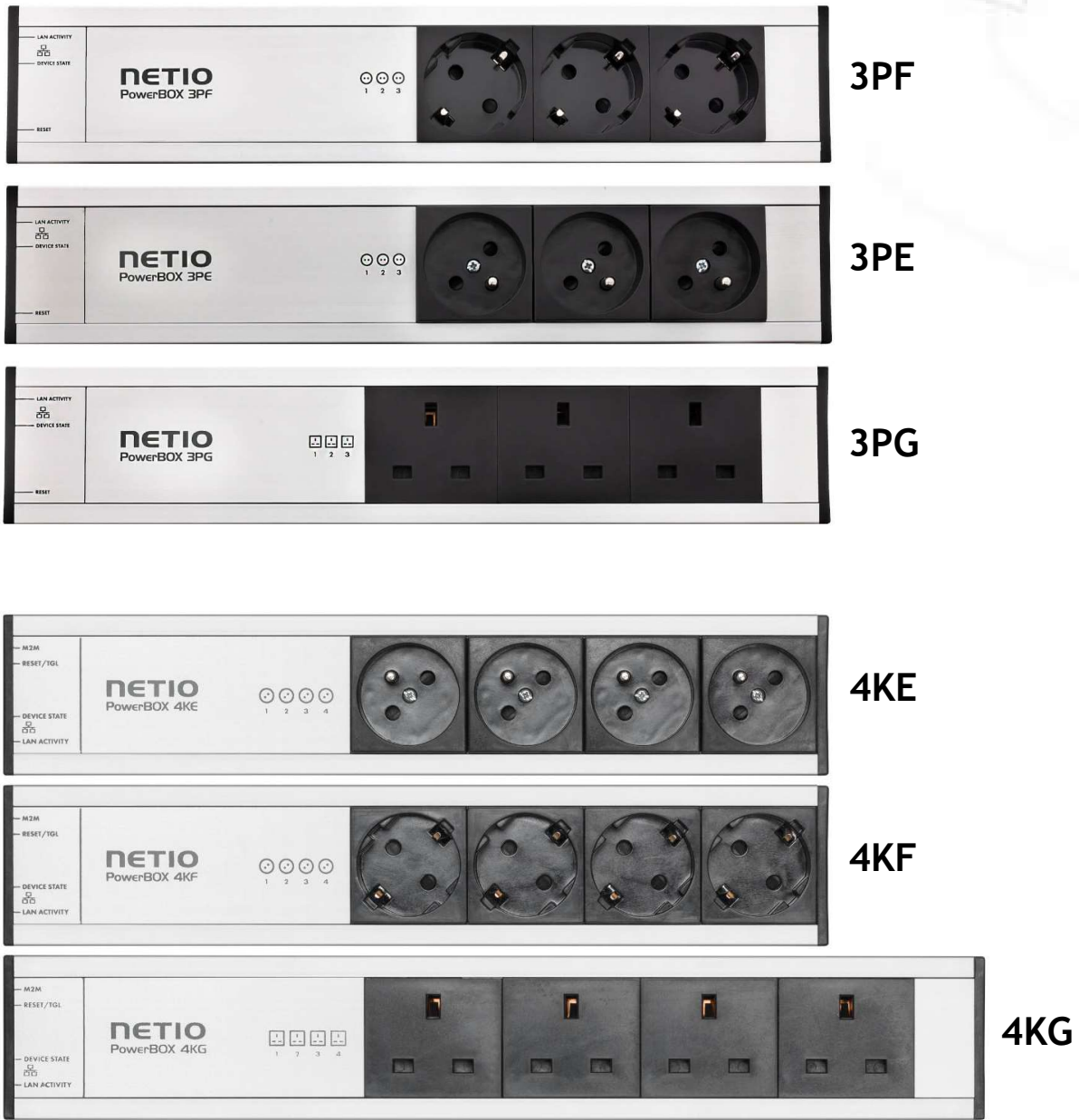

Figure 1 - PowerBOX variants

3 Specifications

Power	100-240 V; 50/60 Hz; 16 A - PowerBOX 3PE, PowerBOX 4KE 100-240 V; 50/60 Hz; 16 A - PowerBOX 3PF, PowerBOX 4KF 100-240 V; 50/60 Hz; 13 A - PowerBOX 3PG, PowerBOX 4KG
Switched outputs	16 A in total / 16 A each output - PowerBOX 3PE, PowerBOX 4KE 16 A in total / 16 A each output - PowerBOX 3PF, PowerBOX 4KF 13 A in total / 13 A each output - PowerBOX 3PG, PowerBOX 4KG
Maximum line breaker capacity	C16A - PowerBOX 3PE, PowerBOX 4KE C16A - PowerBOX 3PF, PowerBOX 4KF C13A - PowerBOX 3PG, PowerBOX 4KG
Fuse	Integrated, non-resettable
Surge protection	Type 3 (CAT III)
Power Output relays	Micro-disconnection (μ) (resistive load), SPST-NO 1E5 switching cycles, max. 1.5 kV pulse voltage Switch heat and fire resistance class 1
Electrical load	PowerBOX 3Px: ZVS (Zero Voltage Switching) - most load types, such as switching power supplies compatible PowerBOX 4Kx: ZCS (Zero Current Switching) - Resistance load compatible - Capacitive load compatible - Inductive load compatible
Network interfaces	1x Ethernet RJ-45 10/100 Mbit/s Attention! Device connected over LAN must be connected in network with same earth potential (PE).
Internal consumption	Max 2W
Environment	IP30, protection rating = class 1 Operating temperature -20°C to 65°C / 10A -20°C to 50°C / 16A Device rated for pollution degree 2. Designed for continuous operation in altitudes up to 2000 m. Does not require additional cooling

3.1 Features

ZCS (Zero Current Switching) - PowerBOX 4Kx

ZCS (Zero Current Switching) function ensures that the relay contact is closed at the moment of zero voltage and opened at the moment when zero current flows through it.

Closing and opening at these exact moments has a number of advantages:

- The negative effects of inrush current on the lifetime of the relay in the NETIO device are significantly reduced.
- Reduced probability of a circuit breaker tripping in the circuit branch where the appliance with a high inrush current is connected.
- Significantly improved lifetime of switching supplies in appliances that are connected to the socket (especially in case of frequent switching on and off).
- Significantly reduced electromagnetic interference caused by repeated switching on and off.

Zero current switching (ZCS) significantly improves the lifetime of the NETIO device and the connected end devices. This function is particularly important in case of frequent switching.

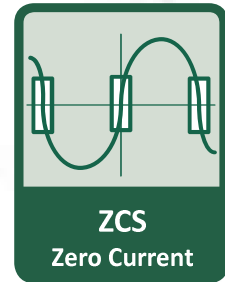

ZVS (Zero Voltage Switching) - PowerBOX 3Px

ZVS (Zero Voltage Switching) means switching the 110/230VAC output when the immediate voltage is zero.

ZVS is a good solution for switching on/off devices such as switching power supplies.

ZVS is not suitable for controlling inductive loads (transformers or motors), as it increases the probability of relay damage when such types of loads are frequently switched on/off.

NETIO products without energy metering support ZVS (Zero Voltage Switching) when switching 110/230V relay outputs.

ZVS is sufficient relay switching technology for most load types, such as switching power supplies in IT solutions.

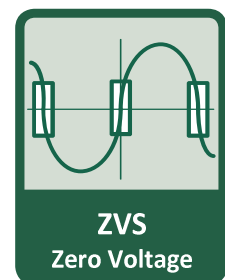

IOC (Independent Output Control)

Independent Output Control function of the NETIO device uses an independent system that ensures a stable operation of the output even if the main system is being restarted, updated, or is booting.

Thanks to IOC, the controlled output can power devices that, for technical reasons, must be powered without interruption (such as servers). The output control is completely independent from the WiFi or LAN communication subsystem.

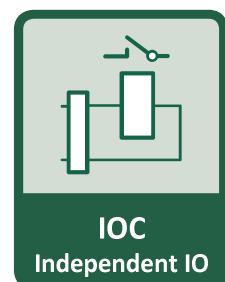

PowerUp State

The PowerUp State parameter (sometimes also called **Cold start**) defines the behavior of the 110/230V power output during the first milliseconds to seconds after powering up the device, before the LAN/WiFi communication with a master system is established.

For some applications, it is important to set the correct state of a power output immediately after power is turned on (or restored). With servers in particular it is important to avoid undesired momentary switching.

Possible settings for NETIO device

- **On**
- **Off**
- **LAST** state restores the last state before the power was disconnected



Electrical measurements - only PowerBOX 4Kx

PowerBOX 4Kx measures relevant electrical parameters.

Parameter	Range	Units	Resolution	Accuracy
Voltage	90,0 - 250,0	V	0,1	<1%
Frequency	45,0 - 65,0	Hz	0,1	<1%
Current	0,005 - 16,000	A	0,001	<1%
TPF (True Power Factor)	0,00 - 1,00	-	0,01	<1%
Phase	0 - 360	°	0,01°	<1%
Output power	0 - 3600	W	1	<1%
Energy	0 - 4294967296	Wh	1	<1%
Reverse Energy	0 - 4294967296	Wh	1	<1%

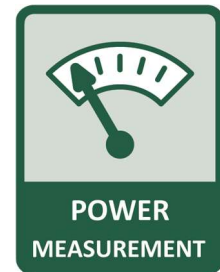

3.2 Drawings

PowerBOX 3Px

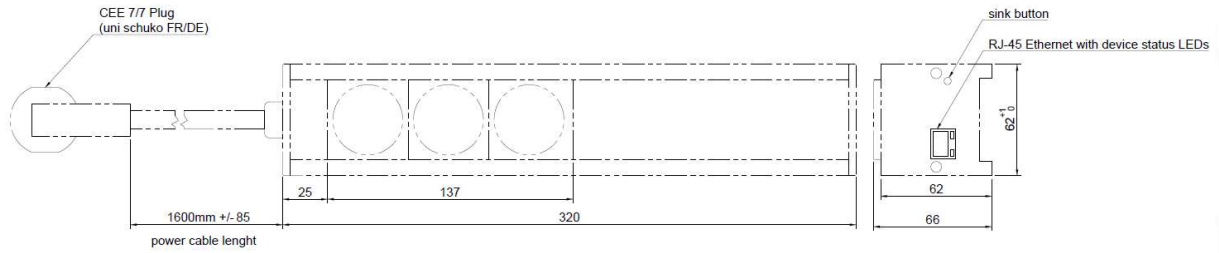
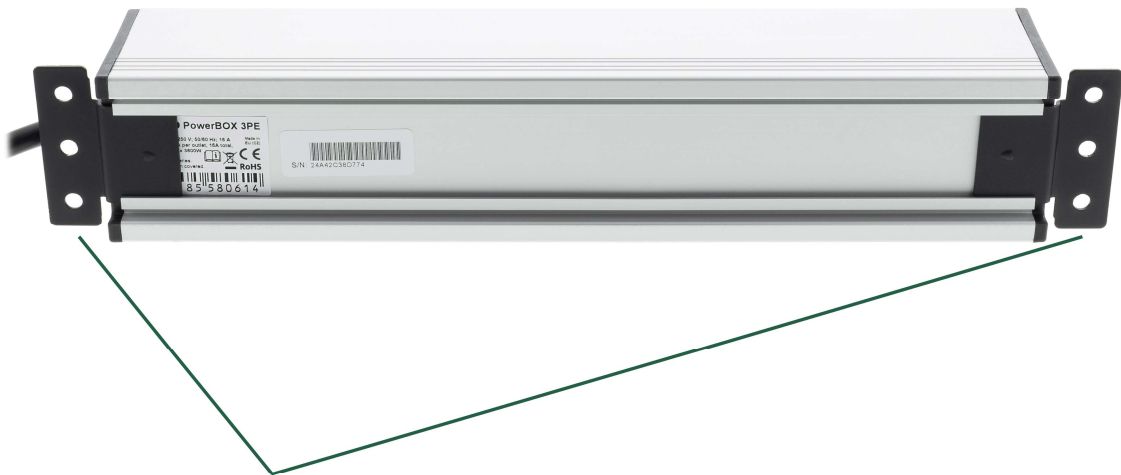

Figure 2 - PoweBOX 3Px front and side view [mm]



Optional accessory: **NETIO MK1 PowerBOX**

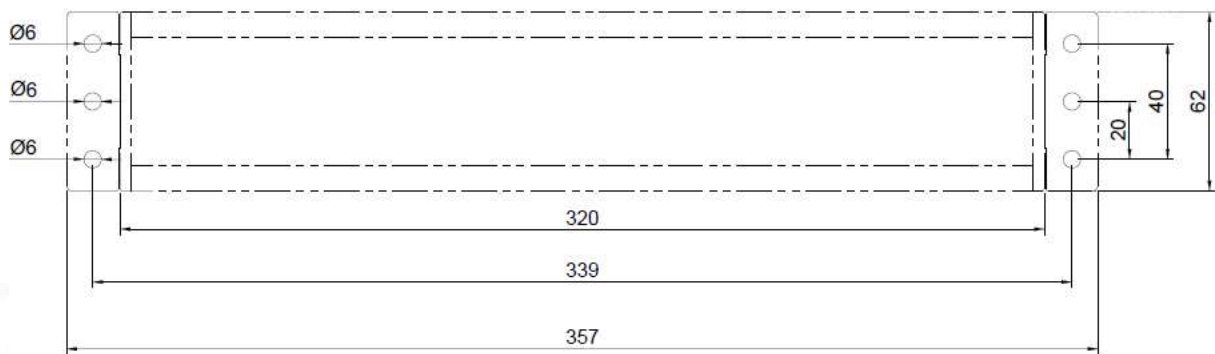

Figure 3 - PoweBOX 3Px - overall dimensions in mm with MK1 kit installed (MK1 sold separately)

PowerBOX 4Kx

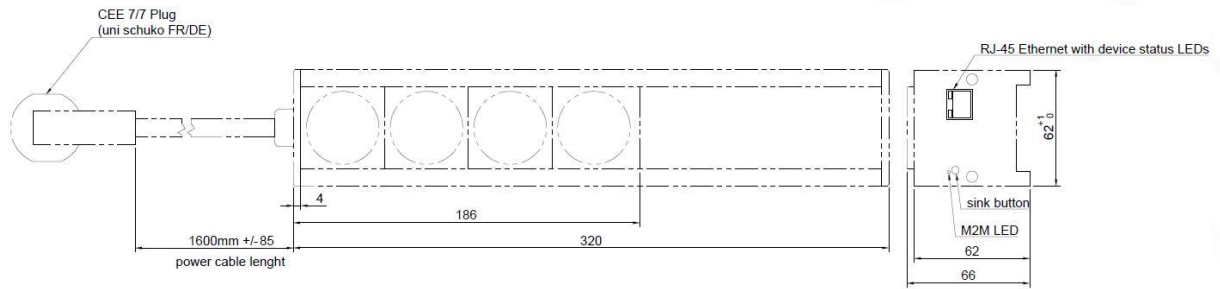

Figure 4 - PoweBOX 4KF or PoweBOX 4KE front and side view [mm]



Optional accessory: **NETIO MK1 PowerBOX**

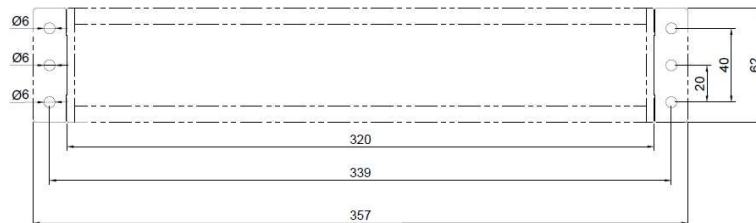

Figure 5 - PoweBOX 4KF or PoweBOX 4 KE with MK1 kit installed [mm] (MK1 sold separately)

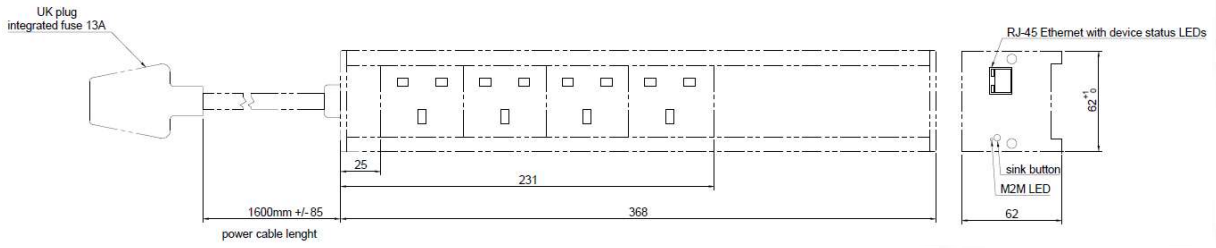

Figure 6 - PoweBOX 4KG front and side view [mm]



Figure 7 - PoweBOX 4KG with MK1 kit installed [mm] (MK1 sold separately)

DIN rail mounting option details

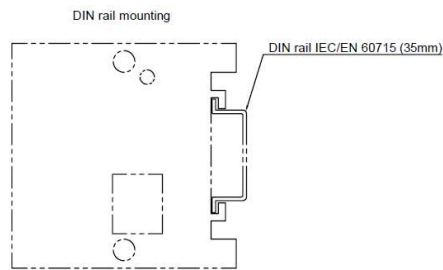

Figure 8 - PoweBOX cut view

3.3 Device description

PowerBOX 3Px

1. 1x RJ45 LAN connector
2. RJ45 LEDs - device states (yellow and green)
3. Multifunction "RESET/TGL" button

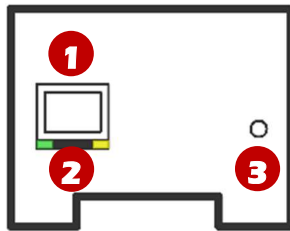

Figure 9 - PowerBOX 3Px description

PowerBOX 4Kx

1. 1x RJ45 LAN connector
2. RJ45 LEDs - device states (yellow and green)
3. Multifunction "RESET/TGL" button
4. M2M activity LED (red)

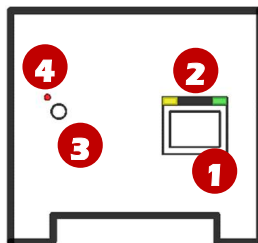

Figure 10 - PowerBOX 4Kx description

3.4 LED and button functions

LED indicators

RJ45 - green	Network Link (lit) + Activity (flashes)
RJ45 - yellow	1x flash when the device starts Flashing (2 sec lit, 1 sec dark) when the Eth cable is disconnected and the device is running (connected to power).
M2M (red) - only PowerBOX 4Kx	Blink when some M2M communication is in progress. Blink when NETIO Cloud communication is in progress. Device Web administration / Mobile app is not indicated.

RESET/TGL button

Switching all outputs	Output test: Press the TGL button 3x rapidly. - If any of output is On (1) -> Off (0). - If all outputs are Off (0), All outputs -> On (1).
Restoring factory defaults	Disconnect the device from the power. Press and hold the RESET button. Connect the device to the power grid (button is pushed) and wait at least 10 seconds until the yellow LED on the RJ45 jack flashes 3 times, release the button. The device reverts to factory settings.

3.5 Minimum system requirements (for configuration)

A device with an Internet browser (Firefox, Chrome, Safari, Microsoft Internet Explorer, Opera, Mozilla etc.) that has JavaScript and cookies enabled.

3.6 Package contents

- NETIO PowerBOX 3Px or PowerBOX 4Kx device with fixed power cable.
- Printed Quick Installation Guide (QIG)

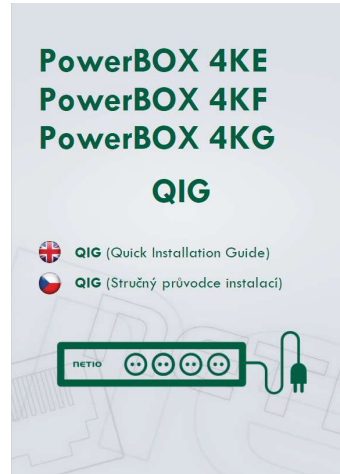

Figure 11 - PowerBOX QIG

3.7 Optional accessories

- NETIO MK1 PowerBOX - wall mounting kit for PowerBOX 3Px and PowerBOX 4Kx devices



Figure 12 - NETIO MK1 PowerBOX

- NETIO MK2 PowerBOX 19 horizontal - Metal brackets (2 pieces) for 1 unit of NETIO PowerBOX 3Px / 4Kx into a 1.5U space in a 19" rack frame



Figure 13 - PowerBOX 4Kx with NETIO MK2 PowerBOX accessories

- NETIO MK3 PowerBOX 19 vertical - Metal brackets to fasten 1 unit of NETIO PowerBOX 3Px / 4Kx to a vertical bar in a rack frame.



Figure 14 - PowerBOX 4KF with NETIO MK3 PowerBOX accesories

4 Configuration and control

4.1 Connecting PowerBOX

NETIO PowerBOX use the Ethernet connection (RJ45) to network.

- Connect your NETIO device to a LAN with a network cable (RJ45).
- Plug the input cable plug into the electrical socket.
- Wait about 30 seconds until the device starts and address is provided from a DHCP server.
- If your network doesn't have DHCP server continue to section [Static IP](#).

4.2 Detecting and configuring the IP address

If you have followed the instructions in the previous chapter, you know the NETIO device's IP address, whether it was assigned by a DHCP server or configured manually. If you forgot the IP address, or if you have received a pre-configured device, you will need to find out its IP address.

Use Windows based NETIO Discover utility, available for download at <http://www.netio-products.com/en/software/netio-discover>.

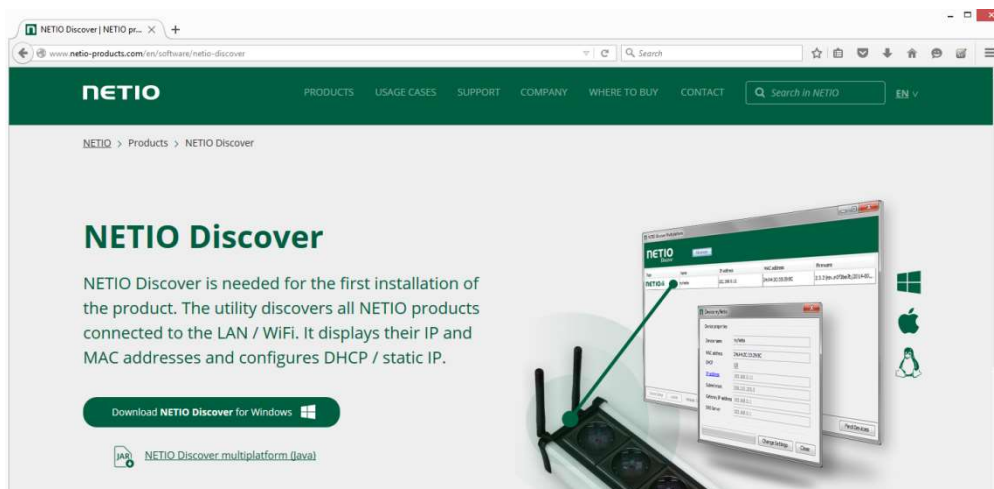

Figure 15 - NETIO Discover web interface

To successfully discover the IP address, the controlling system must be in the same LAN as the NETIO device.

If the discovered IP address belongs to a different address range than that of your network, we recommend resetting the device to factory defaults (see chapter [Restoring factory defaults](#)) and then configuring it according to chapter [Configuration and control](#).

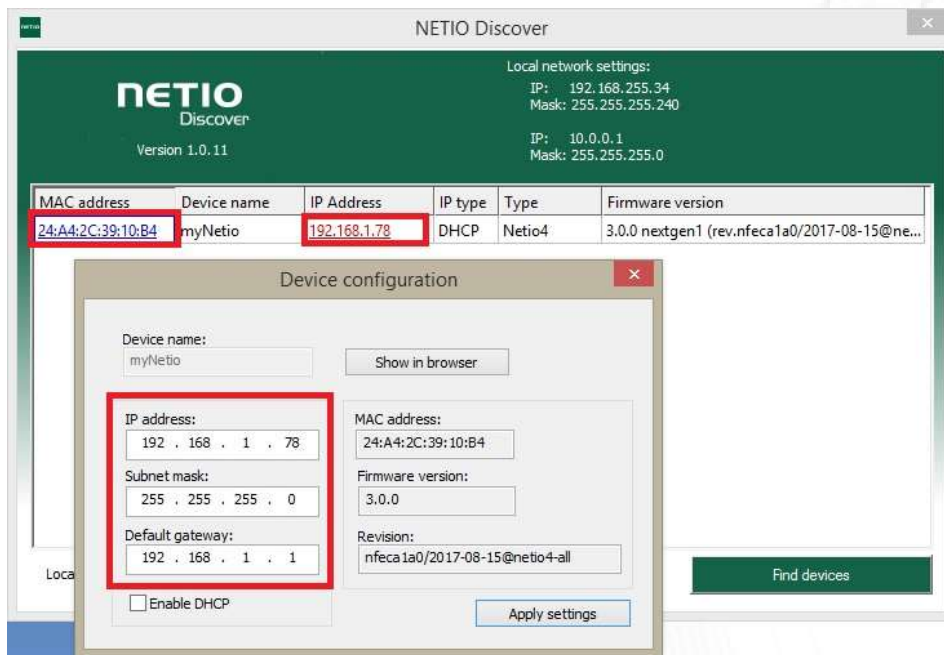

Figure 16 - Discovering and configuring network parameters using NETIO Discover (MS Windows)

The IP address can't be changed and is only for view!

Enter the IP address into a web browser or the NETIO Mobile app and log in to the device.

Note: If you can't use MS Windows app, use NETIO Mobile2 App for iOS or Android. See details in the chapter [NETIO Mobile2](#)

4.3 Static IP

If no DHCP server is available on the network you can use following procedure to activate "Static IP mode":

- Connect the device to LAN, power and switch it on.
- Wait at least 30sec and then press and hold the "TGL/RESET" button for min 10sec. until yellow status LED flashes.
- The device switches to the "Static IP mode" with IP address 192.168.1.78
- Open the WEB interface using <http://192.168.1.78> and log in from computer connected to the same network (or directly to device) and with IP from the same subnet (e.g. 192.168.1.10 mask 255.255.255.0).
- Go to [Settings / Network Configuration](#) and select "Set static IP address", set up IP, mask, GW and click "Save Changes". If not modified and not saved by clicking "Save Changes" the device will use DHCP after the next restart (power off/on) unless the device has been already configured for static IP address before entering the "Static IP mode".

4.4 Login to device web

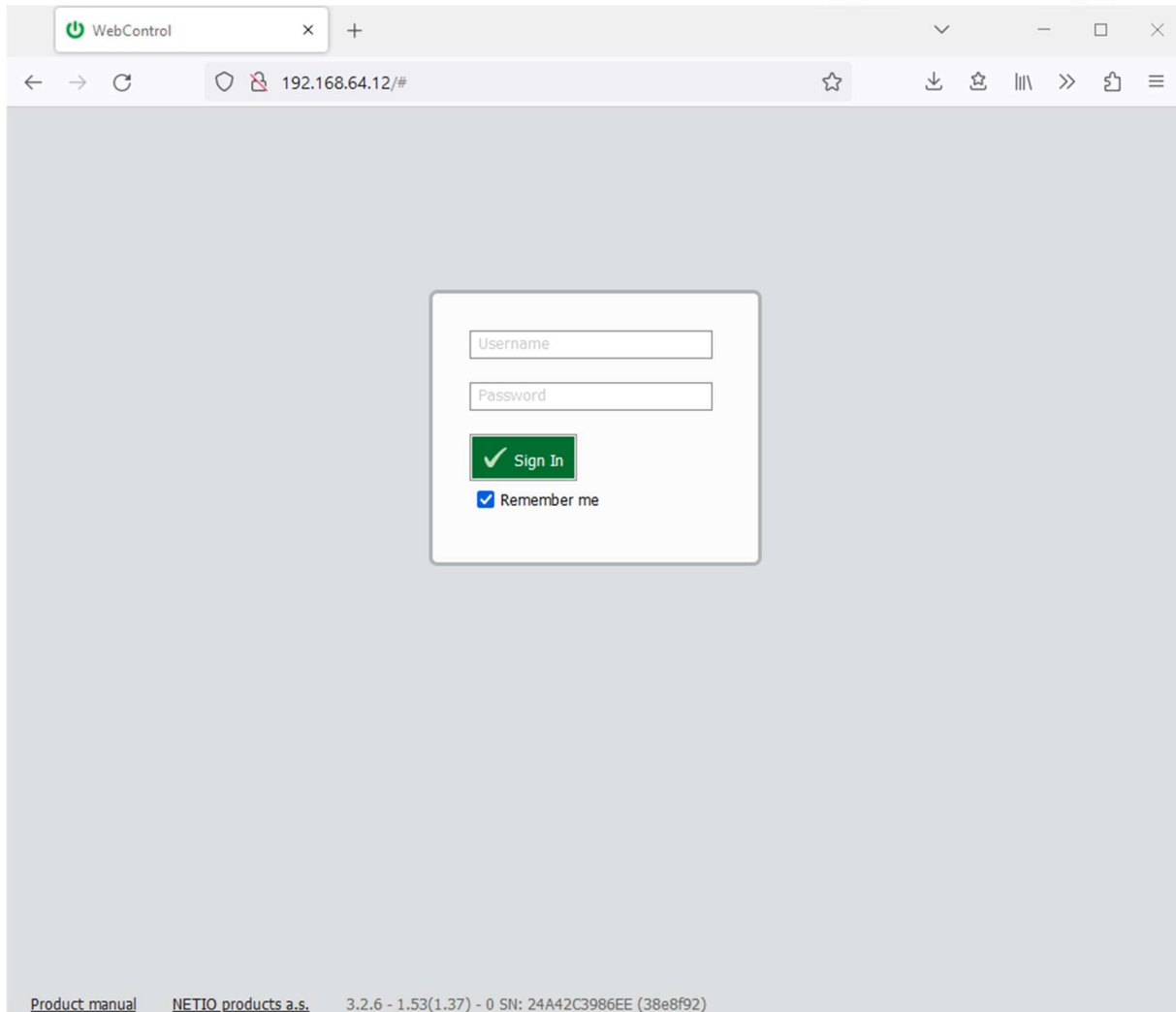

Figure 17 - PowerBOX login dialog

To log in, use **admin / admin**
(default login username / password)

4.5 NETIO Mobile2

NETIO Mobile2 application is for control NETIO devices produced after 2016.

Features:

- Switch On / Off / Restart each power socket/output through local network or NETIO Cloud.
- Show power consumption on each power output (if supported by device).
- Grouping and sorting of the power outputs and the group control (Switch On / Off all outputs in group).
- Searching NETIO devices in local network.
- Add devices from NETIO Cloud.

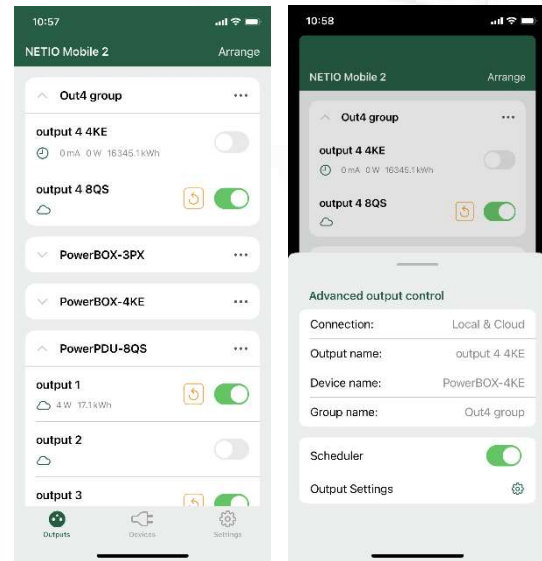

You can use NETIO Mobile 2 application for Android or iOS to discover the local network and find NETIO devices there. Make sure your mobile device is connected to the same network as NETIO device.

1. Start NETIO Mobile 2 app.
2. Android: Touch on “+” in the right bottom corner.
iOS: Touch on “+ Add device” on the “Devices” page.
3. Touch “FIND DEVICES”. The list of all discovered NETIO devices will appear (displaying name, MAC, IP Address).
4. Android: Select the device and touch “CONNECT”.
iOS: Touch the device you’d like to add.
5. the device name, username and password and touch “Connect”.

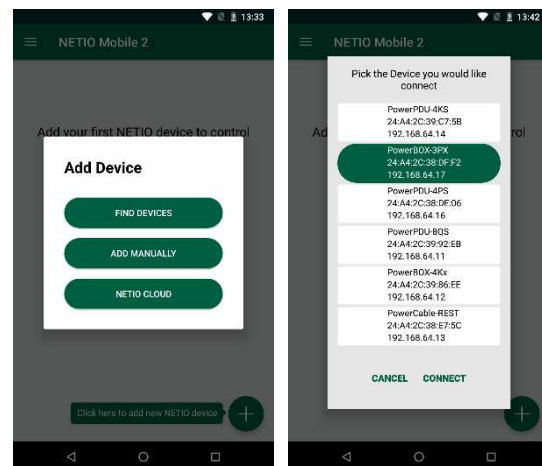

<https://play.google.com/store/apps/details?id=cz.netio.netio>



Android



<https://apps.apple.com/cz/app/netio-mobile-2/id1619326833>



iOS

4.6 Restoring factory defaults

This operation deletes all user settings and restores the configuration to the factory defaults. It is useful when the device is in an unknown state or does not behave as described in this manual.

Procedure:

1. Turn off (unplug) the PowerBOX from power grid.
2. Press and hold the button.
3. Connect the device plug to the power grid (button is still pushed) and wait at least 10 until the yellow LED on the RJ45 jack flashes 3 times, release the button.
4. The device reverts to the factory settings.



Forgotten password

The reset to factory defaults is also used when the password has been forgotten. After restoring the factory defaults, the username and password to access the PowerBOX will be “**admin**” / “**admin**”.

4.7 Controlling the output manually

The outputs can be switched on/off (toggled) by pressing the button quickly 3 times in a row.

1. Press the “TGL” button three times fast to toggle the outputs.

Note: If at least one output is ON the “toggle” by button change all outputs to OFF. If all outputs are OFF the “toggle” change all to ON.

5 Web interface

5.1 Outputs

In the left menu, click **Outputs**. A screen showing the output appears. The output can be controlled directly with two buttons:

The screenshot shows the 'PowerBOX 4KE' web interface. The left sidebar contains a menu with 'Outputs' selected. The main content area displays four power outputs, each with a status indicator (ON/OFF) and a list of technical specifications. A red box highlights the ON/OFF buttons for Power output 1, 2, 3, and 4. The interface includes a sidebar menu with options like M2M API, Cloud, PAB, Watchdogs, Rules, Users, Schedules, Settings, and Log. The top right shows the date, time, and user name (admin) with a Sign out button.

Output	Status	Load	Current	Voltage	Power factor	Phase	Frequency	Energy	Reverse Energy
Power output 1	ON	-3566 W	14.942 A	240 V	0.99	180.2°	50 Hz	38 kWh	20386 ...
Power output 2	OFF	0 W	0 mA	240 V	1	0°	50 Hz	11485 kWh	0 Wh
Power output 3	ON	1.31 kW	7.469 A	240 V	0.72	43°	50 Hz	8732 kWh	27 kWh
Power output 4	ON	3.71 kW	15.512 A	240 V	0.99	0.1°	50 Hz	27134 kWh	11 Wh



All outputs:

Total load:	1.45 kW	Total Energy:	47390 kWh
Total Current:	37.925 A	Total Reverse Energy:	20414 kWh
Total TPF:	N/A	Total Energy NR:	47399 kWh
Total Phase:	N/A	Total Reverse Energy NR:	20414 kWh
Voltage:	240 V		
Frequency:	50 Hz		

Energy measured since 2021-03-09 16:52:53

Product manual | NETIO products a.s. | 3.2.6 - 1.53(1.37) - 0 SN: 24A42C3986EE (38e8f92)

Figure 18 - Controlling the output

1) The  ON/OFF button controls the output directly. When the output is on, the button is green; when the output is off, the button is grey . When switching the output off, a confirmation dialog appears:



Click **Turn Output Off** to confirm the switch-off or **Cancel** to keep the output switched on.

To suppress this dialog in the future, check **Don't ask me again**.

2) The  **Reset** button switches the output off and then back on. It is active only when the output is On. A confirmation is requested before the action is performed. The function is enabled only when the output is switched on. When the output is switched off, the Reset button is disabled.



Click **Reset** to confirm the action or **Cancel** to cancel it.

To suppress this dialog in the future, check **Don't ask me again**.

The  **Scheduler** button enable/disable a Scheduler feature for the specific output. Details and setting are described below at chapter [Outputs - Schedule](#).

5.1.1 Outputs - Energy measurements

PowerBOX 4Kx only

PowerBOX 4Kx measures the following electrical parameters every 500ms for Output 1, 2, 3 and 4. The values in the web interface are updated every 5 seconds.

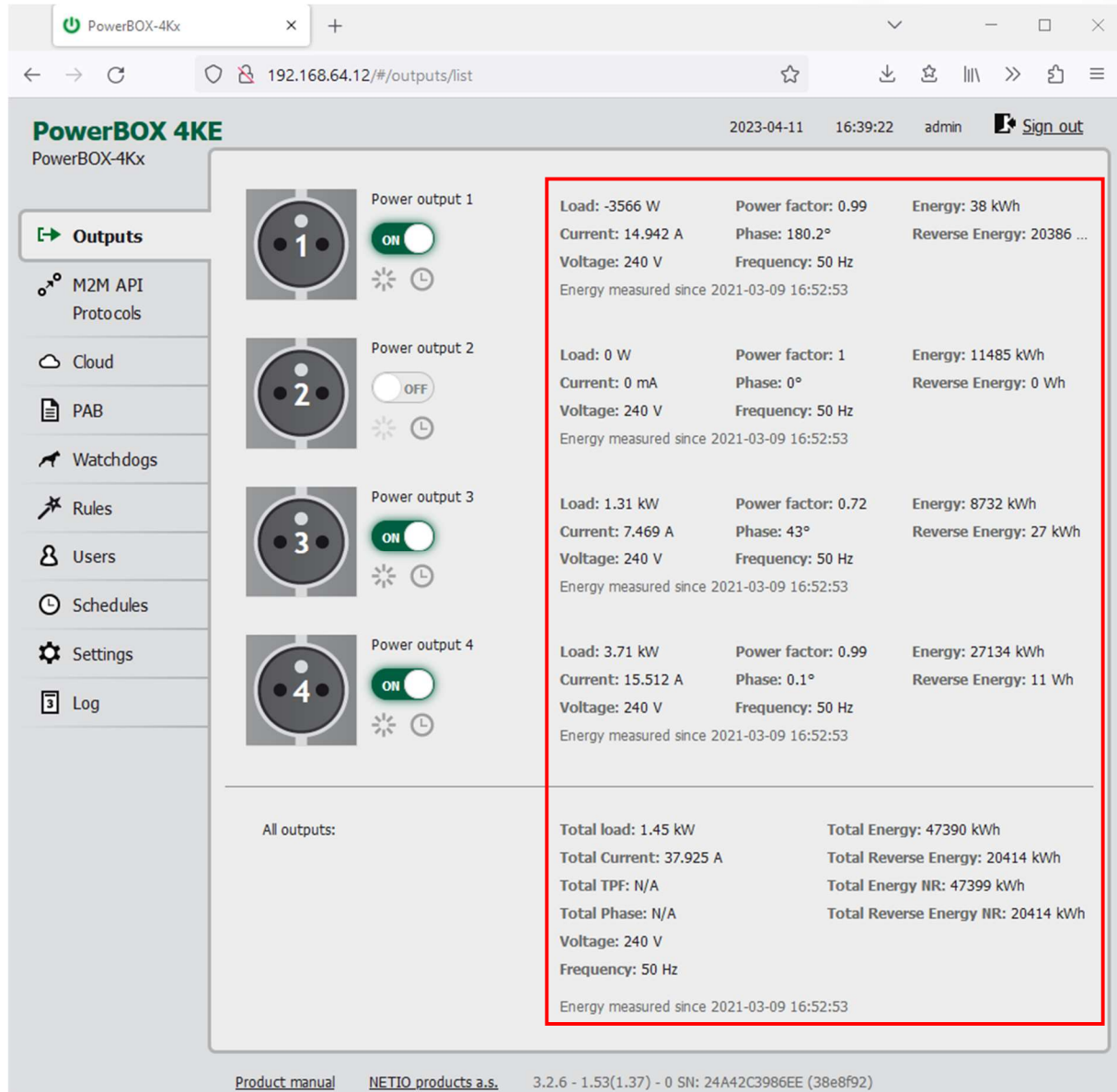

Figure 19 - Measured values

Load in watts [W] corresponds to the immediate current and voltage ($P = U * I * TPF$). It respects the direction - positive value if the connected device consume the energy or negative value if the connected device deliver the power back to the power grid (e.g. solar power system).

Current in amps [A] shows the immediate current flowing through the output. Always positive value.

Voltage in volts [V].

TPF (True Power Factor) shows the ratio of active and apparent power, or the ratio of resistance and impedance. TPF is the ratio of the active power to the apparent power at the power outlet. TPF shows what portion of apparent power is converted by the load to active power. TPF can be viewed

as the sum of useful power and losses. TPF, unlike PF (Power Factor), also takes into account non-sinusoidal waveforms. Such distortions of the sinusoidal waveform are caused e.g. by switching power supplies.

Phase in degrees (°) is the value of a phase shift between current and voltage. Depends on a load type connected to output. The value 0° / 360° means resistive load type.

Frequency in hertz [Hz].

Energy in watt-hours (Wh / kWh) is the cumulative energy consumed over a time interval. The value is the total consumption at the output since the last reset of the counter.

Reverse Energy in watt-hours (Wh / kWh) is the cumulative energy delivered back to grid over a time interval. The value is the total power supply at the output since the last reset of the counter.

All outputs section contains values calculated for the whole device so these apply for the power input cable/connection. Values showing N/A are not available for this type of device. The “Total Energy NR” and “Total Reverse Energy NR” are the non-resettable (NR) counters counting energy since the device has been manufactured and first powered on.

By default, the cumulative Energy consumption/delivery and Total Energy consumption/delivery are counted from the time the NETIO device was first powered on. To reset all Energy counters, go to the **Settings > System** tab and click the **Reset Power Consumption Counters** button (see Figure 18). This restarts the measurements as of the current moment and the date/time shown change.

The screenshot shows the web interface for a PowerBOX 4KE device. The browser address bar shows the URL 192.168.64.12/#/settings/system. The page title is "PowerBOX 4KE" and the user is logged in as "admin". The left sidebar contains navigation options: Outputs, M2M API Protocols, Cloud, PAB, Watchdogs, Rules, Users, Schedules, Settings (highlighted), and Log. The main content area is titled "System" and displays various system information and controls:

- Uptime: 13 days 3 hours 18 minutes
- Firmware version: 3.2.6 - 1.53(1.37) - 0 SN: 24A42C3986EE [Upgrade](#)
- Device name: PowerBOX-4Kx
- HTTP port: 80
- Enable Periodic device restart
- Restart period: 1440 minutes, does not affect the Output state
- [Save Changes](#) (green button)
- [Locate](#) Blink with status LEDs for 1 minute.
- [Reset Power Consumption Counters](#) (button highlighted with a red box)
- [Restore Factory Defaults](#)
- Export and import device configuration:
 - [Export configuration](#)
 - Configuration file: [Procházet...](#) Soubor nevybrán.
 - [Import configuration](#)

The footer contains links for the product manual, NETIO products a.s., and the device's firmware version and SN: 3.2.6 - 1.53(1.37) - 0 SN: 24A42C3986EE (38e8f92).

Figure 20 - Resetting the consumption counters



5.1.2 Outputs - General

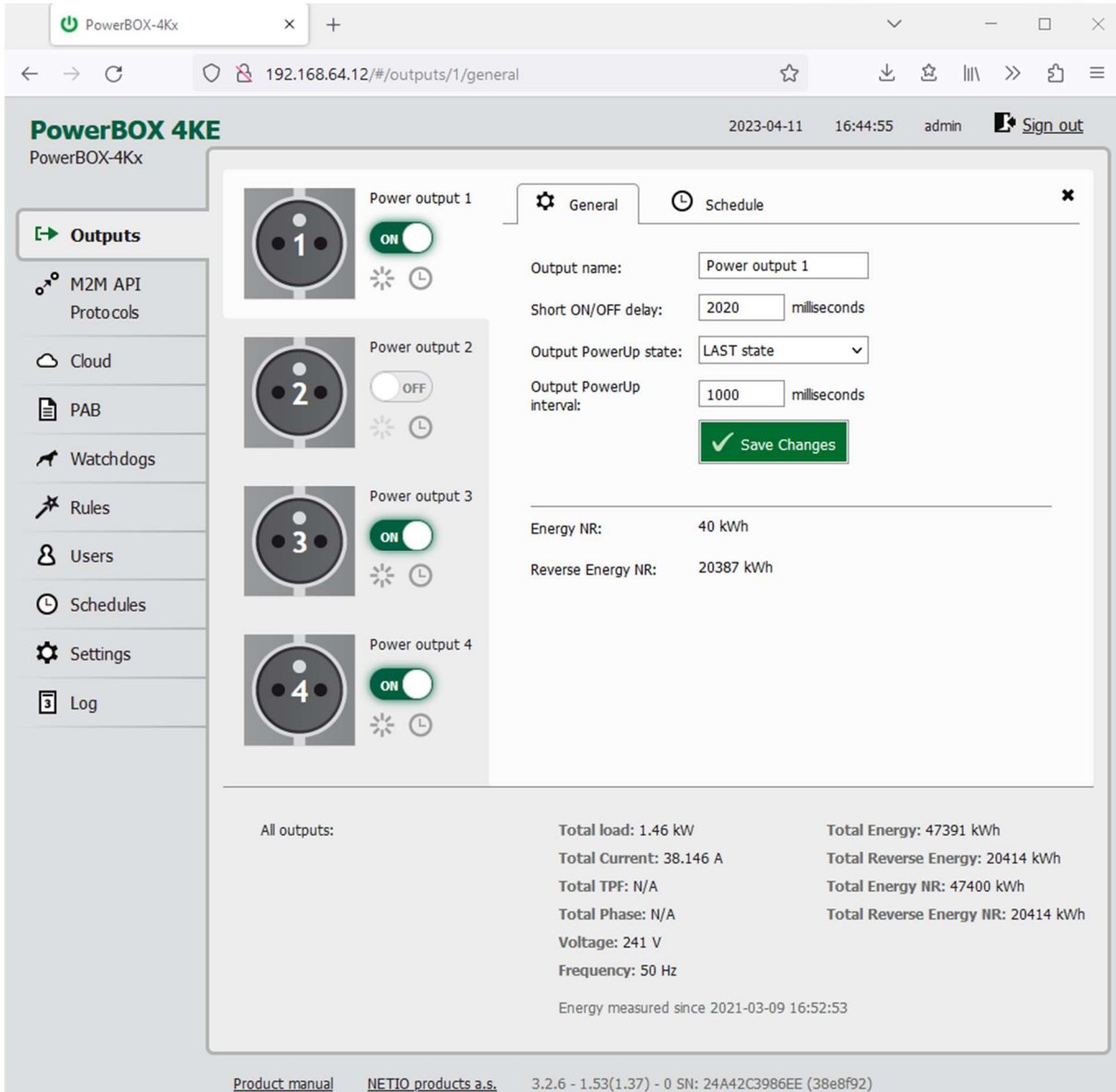

Click the picture of the output to open detailed settings.



The  **General** tab configures basic parameters for controlling the output.





PowerBOX 4KE 2023-04-11 16:44:55 admin [Sign out](#)

Power output 1 ON  

Power output 2 OFF  

Power output 3 ON  

Power output 4 ON  

General **Schedule**

Output name:

Short ON/OFF delay: milliseconds

Output PowerUp state:

Output PowerUp interval: milliseconds

Save Changes

Energy NR: 40 kWh
Reverse Energy NR: 20387 kWh

All outputs:	Total load: 1.46 kW	Total Energy: 47391 kWh
	Total Current: 38.146 A	Total Reverse Energy: 20414 kWh
	Total TPF: N/A	Total Energy NR: 47400 kWh
	Total Phase: N/A	Total Reverse Energy NR: 20414 kWh
	Voltage: 241 V	
	Frequency: 50 Hz	
	Energy measured since 2021-03-09 16:52:53	

[Product manual](#) [NETIO products a.s.](#) 3.2.6 - 1.53(1.37) - 0 SN: 24A42C3986EE (38e8f92)

Figure 21 - General output configuration

Output name is shown above the two control buttons to improve clarity.

Short ON/OFF delay is an integer specifying, in milliseconds, the duration for the Short OFF (power cycling) and Short ON actions.

During this interval, any attempts to switch the output state via M2M API protocols are ignored.

Output PowerUp state defines the state of the output whenever the device is powered up or restarted. The output can be switched on (ON), switched off (OFF), or set to the last state before the restart (LAST). The PowerUp setting is ignored if the Scheduler is enabled for specific output.

Output PowerUp interval defines the interval in milliseconds after which the power output is turned on since the power is turned on (e.g. after the power outage). It is only applied if the “Output PowerUp state” is set to “ON” or “LAST” and the Output was on before.

Maximum value of “Output PowerUp interval” is 43 200 000 ms = 12h

Energy NR in watt-hours (**Wh / kWh**) is the cumulative energy consumed since the device has been manufactured. This counter cannot be resetted. **Only PowerBOX 4Kx shows this value.**

Reverse Energy NR in watt-hours (**Wh / kWh**) is the cumulative energy delivered back to grid since the device has been manufactured. This counter cannot be resetted. **Only PowerBOX 4Kx shows this value.**

Click **Save Changes** to save the settings.

To close the configuration dialog, click the  symbol in the top right corner.

5.1.3 Outputs - Schedule

The  Scheduler function can be used to switch the output on and off at specified times. Select a schedule to specify when the output should be turned on. After selecting a schedule, the on-times for the output according to that schedule are shown graphically. Check **Enable schedule** if you want enable scheduler and Click **Save Changes** to confirm changes. If the Scheduler is enabled the current interval is applied so the output state may change according to selected schedule.

The displayed schedule cannot be changed in the Output - Schedule view. To change a schedule, click **Edit schedules**. It opens the main tab Schedules (details in chapter [Schedules](#)).

To enable or disable the Scheduler for a given output, you may also click the  Scheduler button next to that output. When the Scheduler function is disabled, the outputs stay in their current states. When it is enabled, the outputs are set according to the schedule.

The  Scheduler button / icon next the output indicates Enabled (green) or Disabled (grey) Scheduler function.

Note: When the Scheduler feature is Enabled for specific Output then the PowerUp state is ignored on this Output. The output stays off after power up without Ethernet connection or until the time is synchronized from NTP server. The Scheduler is waiting for the valid time from NTP and this needs Ethernet/Internet connection. It is to respect schedule if state change occurred during the power outage and prevents against for example short power on "peek".

PowerBOX 4KE

Power output 1

ON

Enable schedule

Schedule: Docencia

	All day	3:00	6:00	9:00	12:00	15:00	18:00	21:00
Monday					09:00 – 21:00			
Tuesday					09:00 – 21:00			
Wednesday					09:00 – 21:00			
Thursday					09:10 – 21:00			
Friday					09:00 – 21:00			
Saturday								
Sunday								

Save Changes

The change of selected Schedule will apply immediately if the Schedule feature is already enabled. If the Schedule feature is disabled check the "Enable Scheduler" checkbox above before saving. The Scheduler can be also enabled/disabled any time by the user.

Scheduler on output 1 enabled

Scheduler on output 4 disabled

All outputs:

Total load: 1.47 kW
 Total Current: 38.058 A
 Total TPF: N/A
 Total Phase: N/A
 Voltage: 240 V
 Frequency: 50 Hz
 Energy measured since 2021-03-09 16:52:53

Total Energy: 47391 kWh
 Total Reverse Energy: 20414 kWh
 Total Energy NR: 47400 kWh
 Total Reverse Energy NR: 20414 kWh

Product manual NETIO_products a.s. 3.2.6 - 1.53(1.37) - 0 SN: 24A42C3986EE (38e8f92)

Figure 22 - Configuring the Schedule

5.2 Open API: M2M Protocols

All M2M protocols use the same values for the **action** parameter to control the output. Allowed values are:

- 0 - turns the output off
- 1 - turns the output on
- 2 - short OFF - turns the output off for a short¹ time (if the output was off, it will be turned on)
- 3 - short ON - turns the output on for a short² time (if the output was on, it will be turned off)
- 4 - toggle - toggles the current output state
- 5 - no operation - leaves the output unchanged
- 6 - ignore - ignores the action attribute and only respects the state attribute - only for XML and JSON

Only one M2M protocol in addition to SNMP can be active at any time!

Following M2M API Protocols cannot run in parallel to NETIO Cloud Connection:

- MQTT-flex
- Netio Push

The notification message appears if you try to enable unsupported combination.

^{1,2} The short-off/short-on duration can be also specified in the command issued over the respective M2M protocol. If unspecified, the "Short ON/OFF delay" value is used.

5.2.1 M2M API Protocol - XML over HTTP

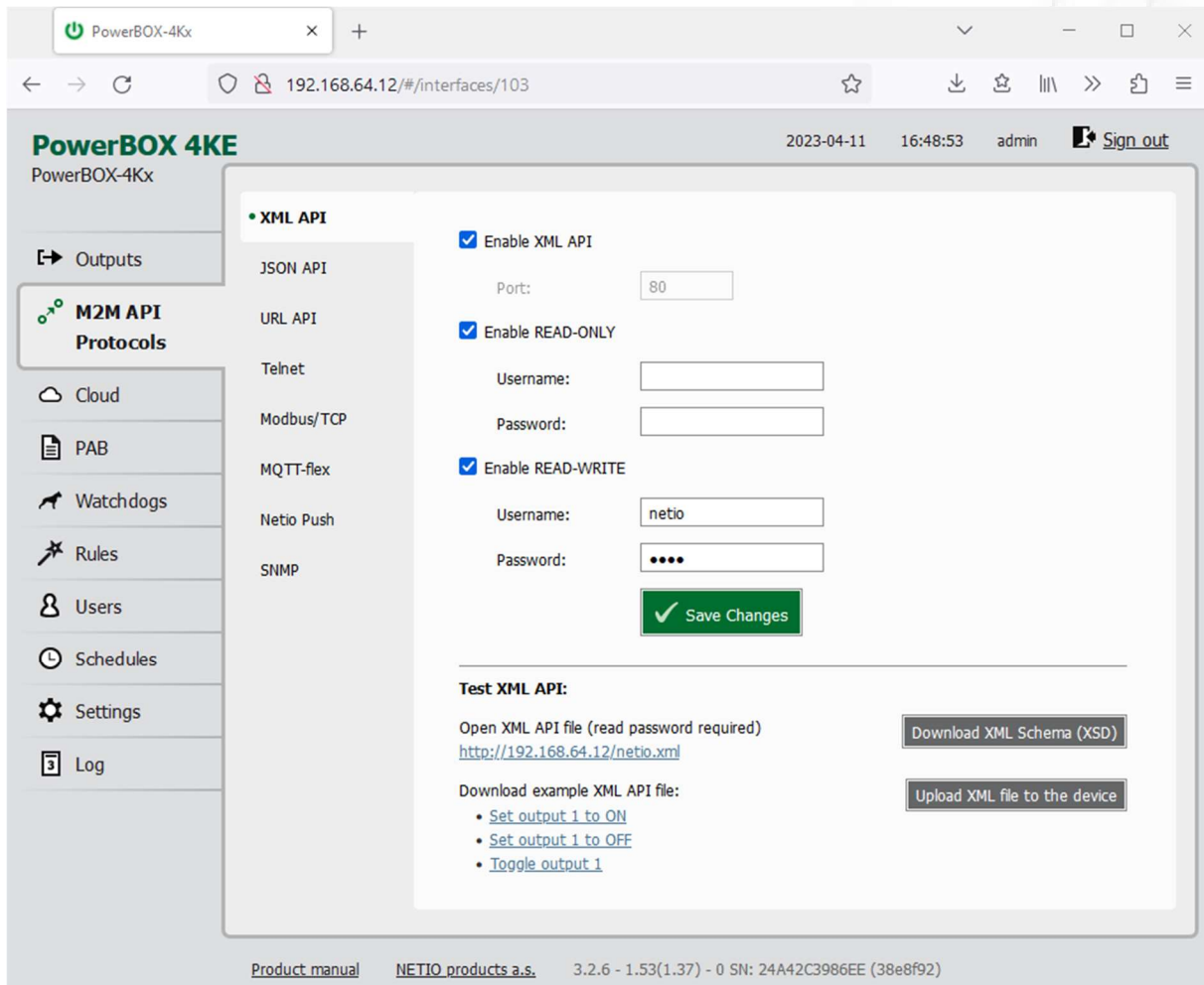

Figure 23 - XML API protocol configuration

Enable XML API	Enables M2M XML API functions in the system.
Port	Read-only value. Indicates the port where the device currently listens for M2M XML API commands. This port is the same for all http based M2M API protocols and web administration and can be changed in Settings / System (chapter System).
Enable READ-ONLY	Enables Read-Only access via M2M XML API for monitoring. You may also fill in the username and password for this mode.
Enable READ-WRITE	Enables Read/Write access for monitoring (reading values) and writing (output control). You may also fill in the username and password for this mode.
Username	Username for the respective access mode (Read-Only/ReadWrite). Note - this is unrelated to the username for accessing the NETIO 4x web administration interface. When left empty, the protocol will not require any authentication.
Password	Password for the corresponding username (Read-Only/ReadWrite).

Save Changes

Saves the changes.

When the XML API is enabled, other M2M protocols are disabled except SNMP. After clicking **Save changes**, the notification message about the deactivation of the other protocol appears.

For an example of reading the output state using XML API, click the “**Test XML API - Open XML API file (read password required)**” link.

After entering the username and password, you will receive an xml file with the NETIO device current state.

URL for downloading/uploading the netio.xml file: <http://<NETIO Device IP>/netio.xml>
e.g. <http://192.168.64.12/netio.xml>

Note: Measurement data available only for PowerBOX 4Kx.

Example of the netio.xml file

```
<?xml version="1.0" encoding="utf-8"?>
<set:Root xmlns:set="http://www.netio-
products.com/XMLSchema/NETIO.xsd">
  <Agent>
    <Model>4KE</Model>
    <DeviceName>PowerBOX-4Kx</DeviceName>
    <OemID>500</OemID>
    <VendorID>0</VendorID>
    <Version>3.2.6</Version>
    <XmlVer>2.4</XmlVer>
    <SerialNumber>24A42C3986EE</SerialNumber>
    <MAC>24:A4:2C:39:86:EE</MAC>
    <Uptime>1135402</Uptime>
    <Time>2023-04-11T16:49:20+01:00</Time>
    <NumOutputs>4</NumOutputs>
    <NumInputs>0</NumInputs>
  </Agent>
  <GlobalMeasure>
    <OverallPowerFactor>999.00</OverallPowerFactor>
    <TotalPowerFactor>999.00</TotalPowerFactor>
    <Voltage>239.99</Voltage>
    <OverallPhase>999.00</OverallPhase>
    <TotalPhase>999.00</TotalPhase>
    <Frequency>49.98</Frequency>
    <TotalLoad>1454</TotalLoad>
    <TotalCurrent>38030</TotalCurrent>
    <TotalEnergy>47391418</TotalEnergy>
    <TotalReverseEnergy>20415014</TotalReverseEnergy>
    <TotalEnergyNR>47400441</TotalEnergyNR>
    <TotalReverseEnergyNR>20415014</TotalReverseEnergyNR>
    <EnergyStart>2021-03-09T16:52:53+01:00</EnergyStart>
  </GlobalMeasure>
  <Outputs>
```



```
<Output>
<ID>1</ID>
<Name>Power output 1</Name>
<State>1</State>
<Action>6</Action>
<Delay>2020</Delay>
<PowerFactor>0.99</PowerFactor>
<Phase>180.37</Phase>
<Load>-3560</Load>
<Current>14952</Current>
<Energy>38603</Energy>
<ReverseEnergy>20387478</ReverseEnergy>
<EnergyNR>40185</EnergyNR>
<ReverseEnergyNR>20387478</ReverseEnergyNR>
</Output>
<Output>
<ID>2</ID>
<Name>Power output 2</Name>
<State>0</State>
<Action>6</Action>
<Delay>2020</Delay>
<PowerFactor>1.00</PowerFactor>
<Phase>0.00</Phase>
<Load>0</Load>
<Current>0</Current>
<Energy>11485192</Energy>
<ReverseEnergy>0</ReverseEnergy>
<EnergyNR>11485638</EnergyNR>
<ReverseEnergyNR>0</ReverseEnergyNR>
</Output>
<Output>
<ID>3</ID>
<Name>Power output 3</Name>
<State>1</State>
<Action>6</Action>
<Delay>2020</Delay>
<PowerFactor>0.72</PowerFactor>
<Phase>43.18</Phase>
<Load>1307</Load>
<Current>7469</Current>
<Energy>8732447</Energy>
<ReverseEnergy>27526</ReverseEnergy>
<EnergyNR>8735370</EnergyNR>
<ReverseEnergyNR>27526</ReverseEnergyNR>
</Output>
<Output>
<ID>4</ID>
<Name>Power output 4</Name>
<State>1</State>
<Action>6</Action>
<Delay>2020</Delay>
<PowerFactor>0.99</PowerFactor>
<Phase>0.14</Phase>
<Load>3718</Load>
<Current>15579</Current>
<Energy>27135177</Energy>
<ReverseEnergy>11</ReverseEnergy>
```

```

<EnergyNR>27139248</EnergyNR>
<ReverseEnergyNR>11</ReverseEnergyNR>
</Output>
</Outputs>
<PAB>
<PABItem><Type>RANGE</Type>
<Name>CR03_PAB</Name>
<Enabled>>false</Enabled>
<In>>false</In>
</PABItem>
</PAB>
<Watchdogs><WdtItem><Name>default_pinger</Name>
<Enabled>>false</Enabled>
<Fail>>false</Fail>
<LastStatus>>false</LastStatus>
<Timestamp>0</Timestamp>
</WdtItem>
</Watchdogs>
<Rules><Rule><Name>Rule1</Name>
<Enabled>>false</Enabled>
<Result>>false</Result>
</Rule>
<Rule><Name>Rule2</Name>
<Enabled>>false</Enabled>
<Result>>false</Result>
</Rule>
<Rule><Name>Rule3</Name>
<Enabled>>false</Enabled>
<Result>>false</Result>
</Rule>
</Rules>
</set:Root>

```

The following example XML files for controlling the device can be downloaded directly from the web administration:

- Set output 1 to ON
- Set output 1 to OFF
- Toggle output 1

Click **Download XML Schema (XSD)** to download the .xsd schema file.

The **Upload XML file to the device** button opens the following dialog for testing:

HTTP(s) file upload

Host:

Port: Method: **HTTP POST**

Username: Password:

Request #1 (e.g. set-output1-to-1.xml)
 No file selected

Request #2 (e.g. set-output1-to-0.xml)
 No file selected

Request #3 (e.g. toggle-output1.xml)
 No file selected

Response

x

Host - URL of the .xml file.

Port - port number used by the XML API protocol.

Username and Password - Username and password configured for the XML API protocol in the READ-WRITE section.

Request #1,2,3 – select .xml file(s) with commands to perform.

Send file - send the selected file(s).

Response - response to the submitted command.

Close - closes the dialog window.

Figure 24 - Upload XML file dialog

For the specifications of the M2M XML API protocol, visit the **Support > Download** section of our website and see the following document:

[XML - description of NETIO M2M API interface - PDF](#)

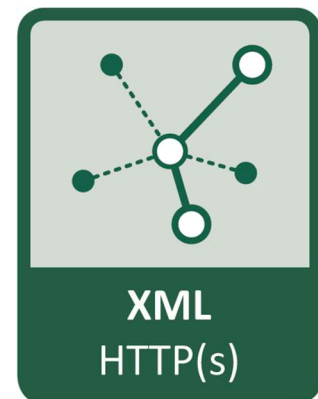

For more information and a practical demonstration of using the XML protocol with NETIO smart sockets, see the following Application Note:

[AN20 XML HTTP\(s\) protocol to control NETIO smart power sockets 110/230V](#)

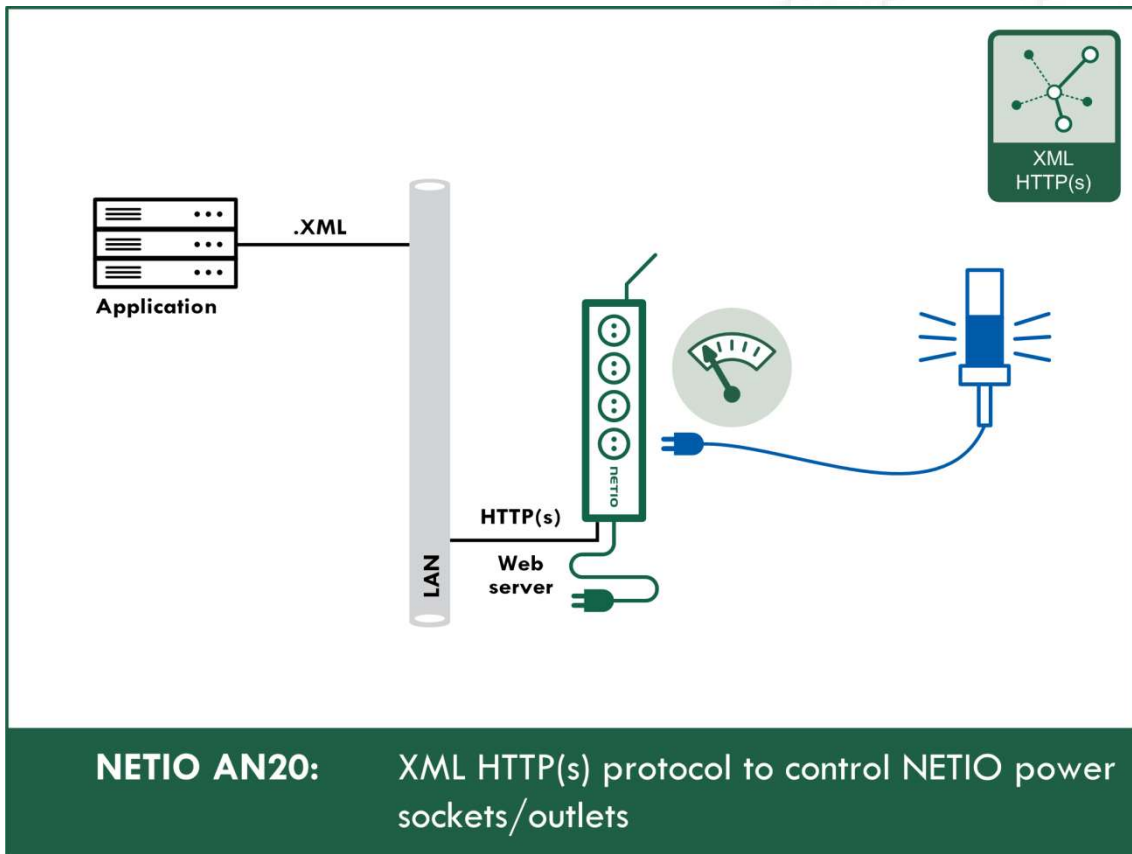

5.2.2 M2M API Protocol - JSON over HTTP

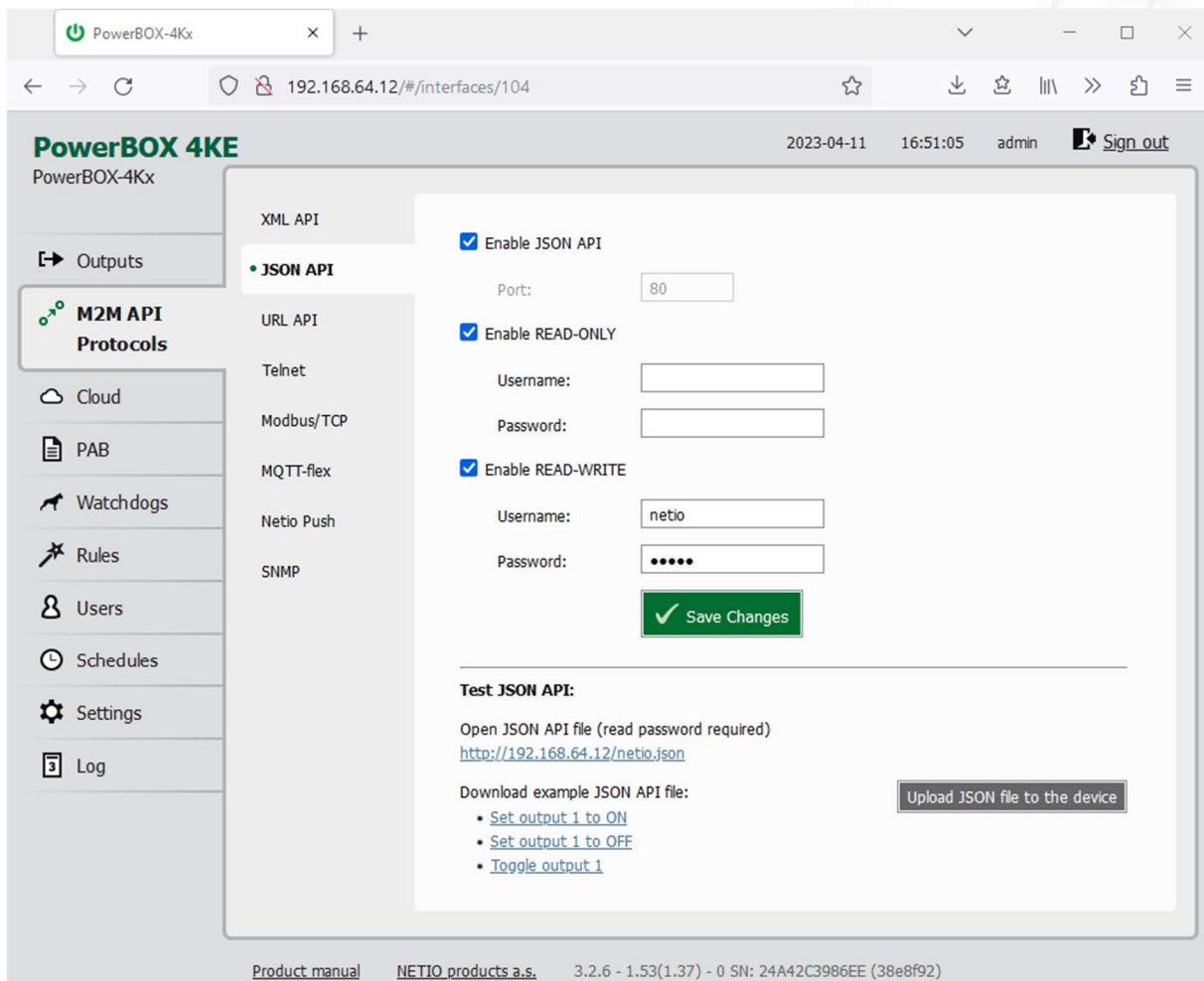

Figure 25 - JSON API protocol configuration

Enable JSON API	Enables M2M JSON API functions in the system.
Port	Read-only value. Indicates the port where the device currently listens for M2M JSON API commands. This port is the same for all http based M2M API protocols and web administration and can be changed in Settings / System (chapter System).
Enable READ-ONLY	Enables Read-Only access via M2M JSON API for monitoring. You may also fill in the username and password for this mode.
Enable READ-WRITE	Enables Read/Write access for monitoring and output control. You may also fill in the username and password for this mode.
Username	Username for the respective access mode (Read-Only/ReadWrite). Note - this is unrelated to the username for accessing the NETIO device web administration. When left empty, the protocol will not require any authentication.
Password	Password for the corresponding username (Read-Only/ReadWrite).
Save Changes	Saves the changes.

When the JSON API protocol is enabled, other M2M protocols are disabled except SNMP. After clicking **Save changes**, the notification message about the deactivation of the other protocol appears.

For an example of reading the output state using JSON API, click the “**Test JSON API: Open JSON API file (read password required)**” link.

After entering the username and password, you will receive a json file with the NETIO device current state.

URL for downloading/uploading the netio.json file: <http://<NETIO Device IP>/netio.json>
e.g. <http://192.168.64.12/netio.json>

Note: Measurement data available only for PowerBOX 4Kx.

Example of the netio.json file

```
{
  "Agent": {"Model": "4KE", "DeviceName": "PowerBOX-4Kx", "MAC": "24:A4:2C:39:86:EE", "SerialNumber": "24A42C3986EE", "JSONVersion": "2.4", "Time": "2023-04-11T16:51:59+01:00", "Uptime": 1135561, "Version": "3.2.6", "OemID": 500, "VendorID": 0, "NumOutputs": 4, "NumInputs": 0},
  "GlobalMeasure": {"Voltage": 239.53, "TotalCurrent": 37962, "OverallPowerFactor": 999.00, "TotalPowerFactor": 999.00, "OverallPhase": 999, "TotalPhase": 999, "Frequency": 50.03, "TotalEnergy": 47391641, "TotalReverseEnergy": 20415173, "TotalEnergyNR": 47400663, "TotalReverseEnergyNR": 20415173, "TotalLoad": 1449, "EnergyStart": "2021-03-09T16:52:53+01:00"},
  "Outputs": [
    {"ID": 1, "Name": "Power output 1", "State": 1, "Action": 6, "Delay": 2020, "Current": 14933, "PowerFactor": 0.99, "Phase": 180.08, "Energy": 38603, "ReverseEnergy": 20387636, "EnergyNR": 40185, "ReverseEnergyNR": 20387636, "Load": -3553},
    {"ID": 2, "Name": "Power output 2", "State": 0, "Action": 6, "Delay": 2020, "Current": 0, "PowerFactor": 1.00, "Phase": 0.00, "Energy": 11485192, "ReverseEnergy": 0, "EnergyNR": 11485638, "ReverseEnergyNR": 0, "Load": 0},
    {"ID": 3, "Name": "Power output 3", "State": 1, "Action": 6, "Delay": 2020, "Current": 7459, "PowerFactor": 0.73, "Phase": 43.18, "Energy": 8732504, "ReverseEnergy": 27526, "EnergyNR": 8735427, "ReverseEnergyNR": 27526, "Load": 1304},
    {"ID": 4, "Name": "Power output 4", "State": 1, "Action": 6, "Delay": 2020, "Current": 15549, "PowerFactor": 0.99, "Phase": 0.14, "Energy": 27135342, "ReverseEnergy": 11, "EnergyNR": 27139413, "ReverseEnergyNR": 11, "Load": 3706}
  ]
}
```

```
],  
"PAB": [  
  {"Type": "RANGE", "Name": "CR03_PAB", "Enabled": false, "In": false}  
],  
"Watchdogs": [  
  {"Name": "default_pinger", "Enabled": false, "Fail": false, "LastStatus": false, "Timestamp": 0}  
],  
"Rules": [  
  {"Name": "Rule1", "Enabled": false, "Result": false},  
  {"Name": "Rule2", "Enabled": false, "Result": false},  
  {"Name": "Rule3", "Enabled": false, "Result": false}  
]}
```

The following example json files for controlling the device can be downloaded directly from the web administration:

- Set output 1 to ON
- Set output 1 to OFF
- Toggle output 1

The **Upload JSON file to the device** button opens the following dialog for testing:

HTTP(s) file upload

Host:

Port: Method: **HTTP POST**

Username: Password:

Request #1 (e.g. set-output1-to-1.json)
 No file selected

Request #2 (e.g. set-output1-to-0.json)
 No file selected

Request #3 (e.g. toggle-output1.json)
 No file selected

Response

Figure 26 - Upload JSON file dialog

Host - URL of the .json file.

Port - port number used by the JSON protocol.

Username and Password - username and password configured for the JSON protocol in the READ-WRITE section.

Request #1,2,3 – select .json file(s) with commands to perform.

Send file - send the selected file(s).

Response - response to the submitted command.

Close - closes the dialog window.

For more information about the M2M JSON API, visit the **Support > Download** section of our website and see the following document:

[JSON - description of NETIO M2M API interface - PDF](#)

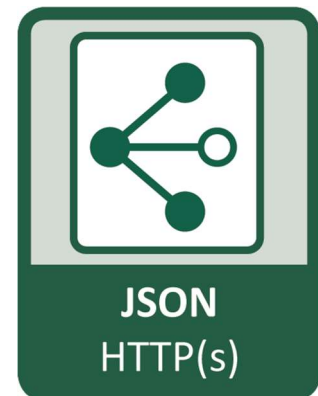

For more information and a practical demonstration of using the JSON protocol with NETIO smart sockets, see the following Application Note:

[AN21 JSON HTTP\(S\) protocol to control NETIO 110/230V power sockets \(3x REST API\)](#)

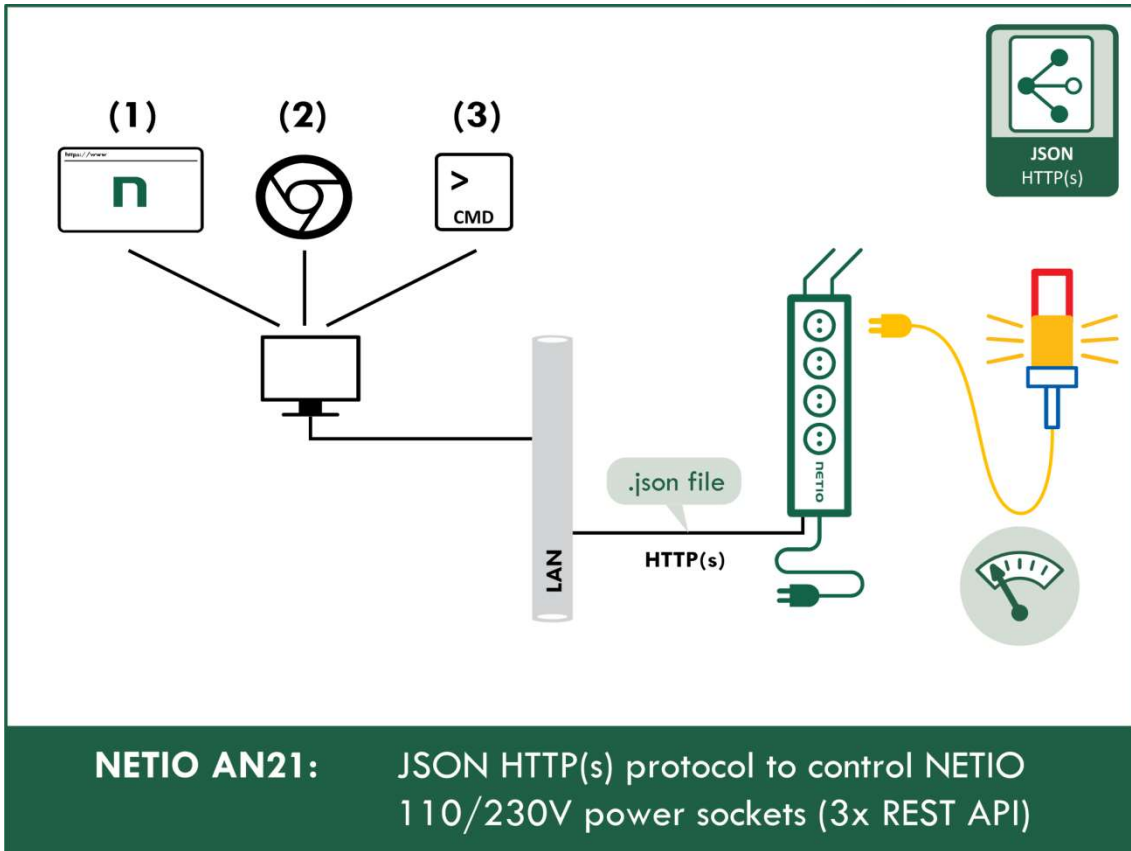

5.2.3 M2M API Protocol - URL API (http get)

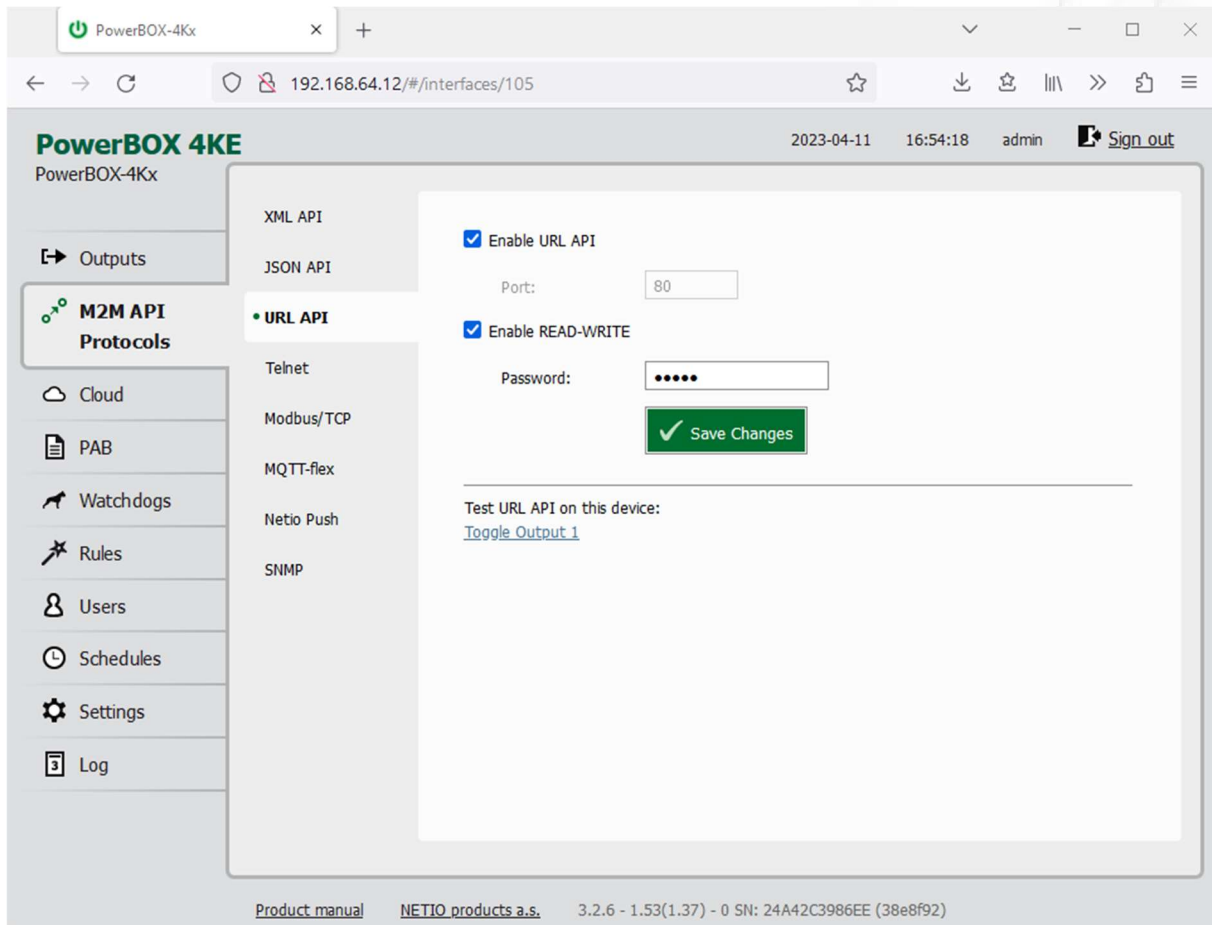

Figure 27 -URL API protocol configuration

Enable URL API	Enables M2M URL API functions in the system.
Port	Read-only value. Indicates the port where the device currently listens for M2M URL API commands. This port is the same for all http based M2M API protocols and web administration and can be changed in Settings / System (chapter System).
Enable READ-WRITE	Enables READ-WRITE access.
Password	Password to authenticate HTTP GET communication (pass attribute in the request).
Save Changes	Saves the changes.

URL API protocol does not contain energy measurement data and counters. URL API also do not provide information about current output states. This protocol is recommended to Outputs control only.

When the URL API is enabled, other M2M protocols are disabled except SNMP. After clicking **Save changes**, the notification message about the deactivation of the other protocol appears.

For an example of toggling output no. 1 using the M2M URL API, click the link under **Test URL API**.

This opens a new browser tab and invokes the following HTTP GET request:

`http://<NETIO Device IP>/netio.cgi?pass=<Password>&output1=4`

e.g. `http://192.168.64.12/netio.cgi?pass=netio&output1=4`

For more information about the M2M URL API, visit the **Support > Download** section of our website and see the following document:

[URL API - description of NETIO M2M API interface - PDF](#)



For more information and a practical demonstration of using the URL-API protocol with NETIO smart sockets, see the following Application Note:

[AN19 URL API \(http GET\) protocol to control NETIO 4x power sockets/outlets 110 / 230V](#)

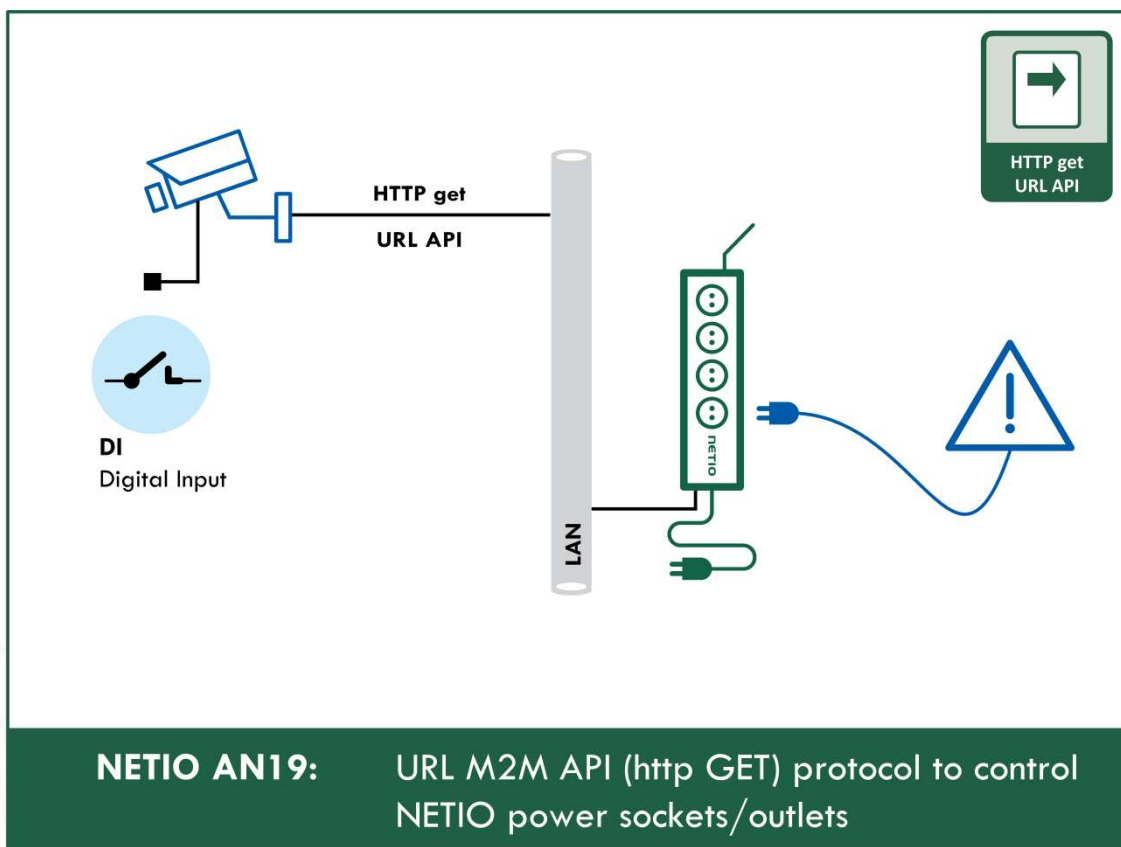

5.2.4 M2M API Protocol - Telnet

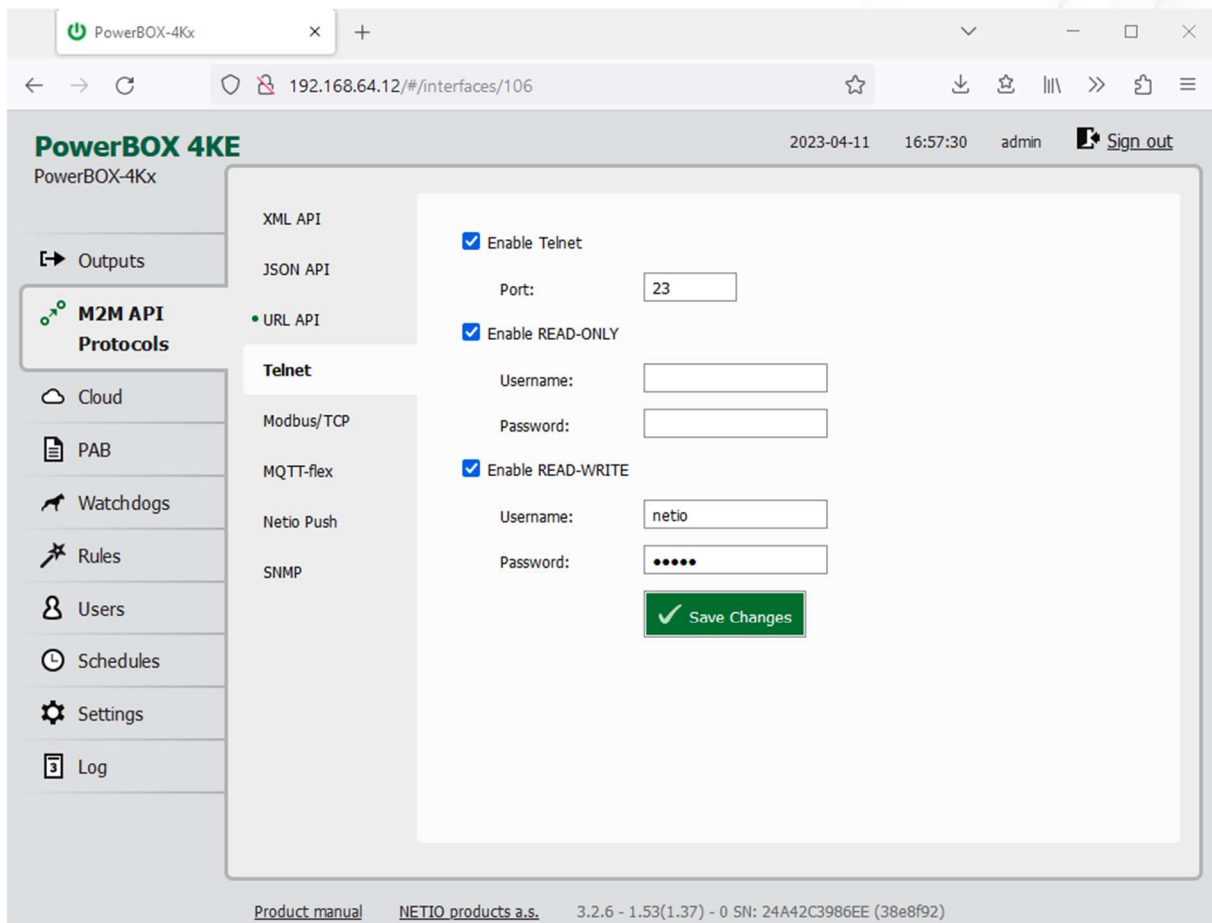

Figure 28 -Telnet protocol configuration

Enable Telnet	Enables M2M Telnet functions in the system.
Port	Specific port for Telnet only, range 1 - 65535. Be aware, that you should enter value, which is not already occupied by another M2M protocol or web interface.
Enable READ-ONLY	Enables Read-Only access via M2M Telnet API for monitoring. You may also fill in the username and password for this mode.
Enable READ-WRITE	Enables Read/Write access for monitoring and output control. You may also fill in the username and password for this mode.
Username	Username for the respective access mode (Read-Only/ReadWrite). Note - this is unrelated to the username for accessing the NETIO device web administration. When left empty, the protocol will not require any authentication.
Password	Password for the corresponding username (Read-Only/ReadWrite).
Save Changes	Saves the changes.

Telnet protocol does not contain energy measurement data and counters. This protocol is recommended to Outputs control only.

When the Telnet is enabled, other M2M protocols are disabled except SNMP. After clicking **Save changes**, the notification message about the deactivation of the other protocol appears.

Start Telnet connection to a NETIO device IP address and its Telnet port

When the connection is established, the NETIO device returns the following response and is ready to receive commands.

Telnet welcome message

```
100 HELLO 4213C6D7 - KSHELL V2.2
```

Note: The Telnet connection is automatically terminated after 60 seconds of inactivity. It is possible to use the *noop* command to keep the connection alive for the next 60 seconds.

Command set

Command	Description
login <username> <password>	Log in a user. Replace <username> and <password> by the equivalent attributes defined in the Telnet protocol configuration (Figure 28) <password> Example - log in with username <i>netio</i> and password <i>netio</i> : login netio netio
quit	Log out and terminate Telnet connection.
noop	Keep the Telnet connection alive for the next 60 seconds. No-operation
port list [xxxx]	Control/monitor of all outputs based on the parameters xxxx (described below) for each output. All parameters x must have valid value otherwise the command will not be accepted (e.g. port list 10x1 is invalid). If no parameters are provided, then it returns states of all outputs.

	<p>Outputs are numbered from the left to right (1-2-3-4).</p> <p>Control all outputs (1 and 4: ON, 2 and 3: OFF):</p> <pre>port list 1001 250 OK</pre> <p>Returns state of output:</p> <pre>port list 250 1001</pre> <p><i>(outputs 1 and 4 are ON, 2 and 3 OFF)</i></p>
port <output> <action>	<p>Control the output.</p> <p><output> is replaced by the output number (1)</p> <p><action> is replaced by a parameter described below</p> <p>If no <action> is provided, the state of the output is returned.</p>
input list	<p>Returns state of input.</p> <pre>input list 250 10</pre> <p><i>(input is ON)</i></p>

Each command must be followed by CR and LF characters (hexadecimal 0D and 0A). Typically, you can use Enter in the terminal.

Parameters <action> for *port* command

Parameter	Action
0	Turn OFF
1	Turn OFF
2	Short OFF delay (restart)
3	Short ON delay
4	Toggle (invert the state)
5	No change

Command examples

Switch power output 1 to ON:

```
port 1 1
```

Switch power output 1 to OFF:

```
port 1 0
```

Toggle power output 1:

```
port 1 4
```

Status codes

Status code	Description
110 BYE	Connection terminated by client after command quit
130 CONNECTION TIMEOUT	No command submitted for longer than 60 seconds. The Telnet connection is terminated.
250 OK	The command is accepted.
500 INVALID VALUE	The command parameter is not valid.
501 INVALID PARAMETR	The command parameter is not valid.
502 UNKNOWN COMMAND	The command is not valid.
505 FORBIDDEN	An attempt to make an action with not sufficient permission (i.e.: control output with read only user, try to monitor output state with non-logged user, where ReadOnly user is password protected etc.)
510 OUT OF RANGE	Specified value is not valid (i.e. trying to control port 4 on device, which has only 1 socket)

For more information about the Telnet protocol, visit the **Support > Download** section of our website and see the following document:

[Telnet - description of NETIO M2M API interface - PDF](#)



For more information and a practical demonstration of using the Modbus/TCP protocol with NETIO smart sockets, see the following Application Note:

[AN10 Telnet control of electrical power sockets \(M2M API - KShell\)](#)

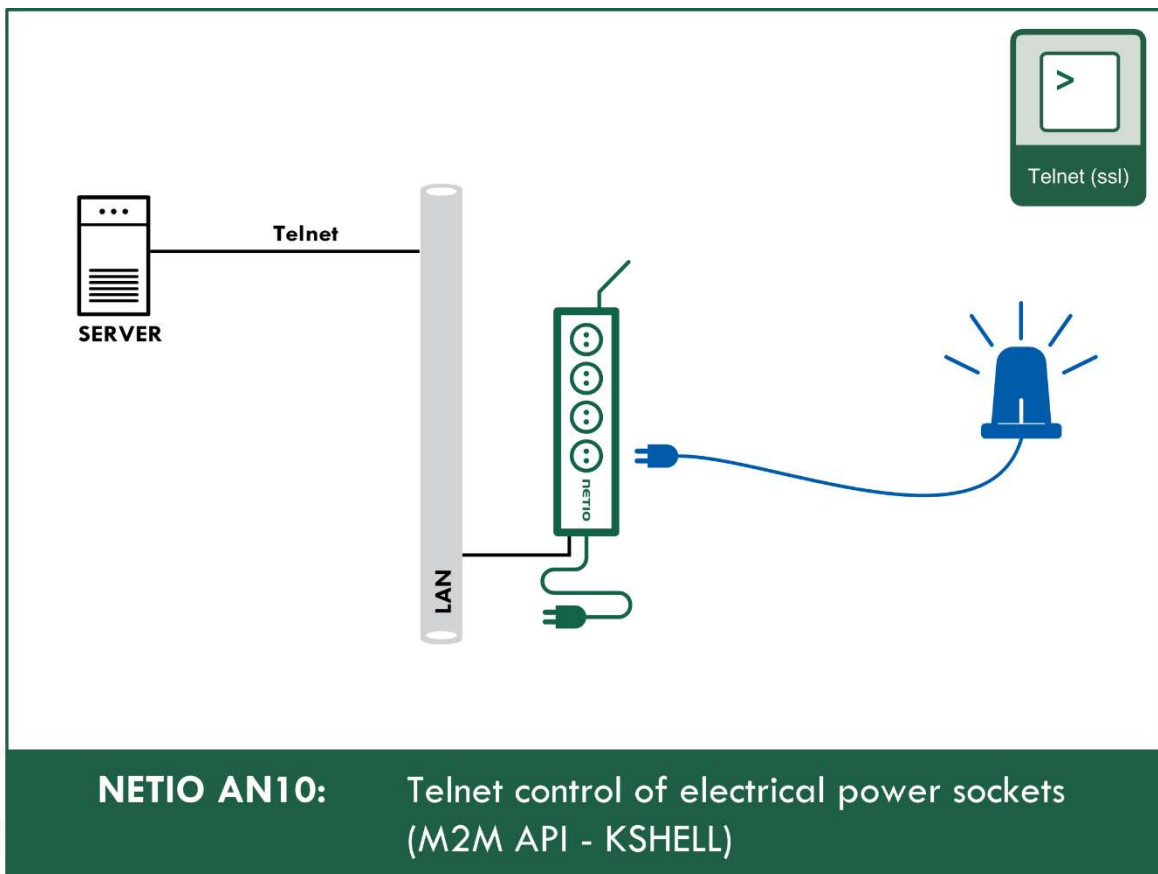

5.2.5 M2M API Protocol - Modbus/TCP

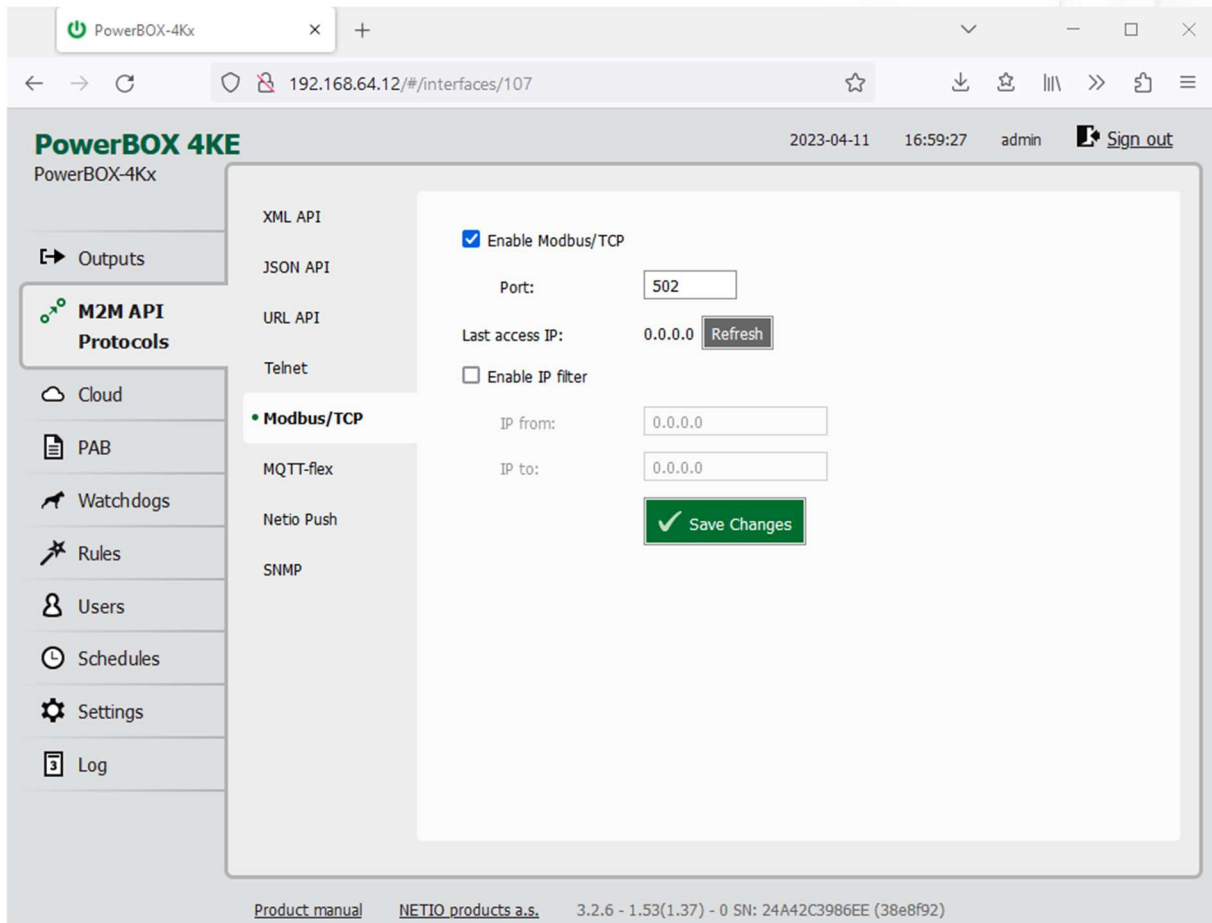

Figure 29 - Modbus/TCP protocol configuration

Enable Modbus/TCP	Enables M2M Modbus/TCP functions in the system.
Port	Specific port for Modbus/TCP only, range 1 - 65535. The device do NOT alerts you if you specify a port number that is already occupied.
Last access IP	Read-only value indicating the IP address from which the last Modbus/TCP command was received. The “Refresh” button updates this value.
Enable IP filter	To improve security, the IP filter can be used to specify a range of IP addresses from which Modbus/TCP commands are accepted. Commands from addresses outside of this range will be ignored.
Save Changes	Saves the changes.

Note: Measurement available only for PowerBOX 4Kx.

When the Modbus/TCP is enabled, other M2M protocols are disabled except SNMP. After clicking **Save changes**, the notification message about the deactivation of the other protocol appears.

Protocol properties

- Modbus/TCP Unit ID is ignored. Can be anything 0 to 247
- **Wire Address = Register Address - 1**
 - The Wire Address starts from 0
 - The Register Address starts from 1
 - Register Address is called “PLC based addressing” in some applications (Modbus Poll for example)
 - Some utilities using the Wire Address (QModMaster used in AN27 for example)

Modbus/TCP function and registers overview (Register addresses used and Wire address in brackets on the first line)

Function	Register	Value	Description
0x01	102 (101)	0/1	Read 1st output state (101 when Wire address used)
0x01	103	0/1	Read 2nd output state
0x01	104	0/1	Read 3rd output state
0x01	105	0/1	Read 4th output state
0x03	1	uInt16	Number of digital inputs
0x03	2	uInt16	Number of digital outputs
0x03	3	uInt16	Number of metered digital outputs
0x03	102	uInt16	1st output state
0x03	103	uInt16	2nd output state
0x03	104	uInt16	3rd output state
0x03	105	uInt16	4th output state
0x03	202	uInt16	"Short" delay of 1st output [1/10sec]
0x03	203	uInt16	"Short" delay of 2nd output [1/10sec]
0x03	204	uInt16	"Short" delay of 3rd output [1/10sec]
0x03	205	uInt16	"Short" delay of 4th output [1/10sec]
0x04	1	uInt16	Power grid frequency [1/100 Hz]
0x04	2	uInt16	Voltage [V*10] - RMS
0x04	3	uInt16	OverAll TruePowerFactor [1/1000] (value 9999=not measured)
0x04	4	uInt16	All outputs current [mA] (double)
0x04	5	uInt16	All outputs power [W] (double)
0x04	6	Int16	All outputs Phase shift [1/10°] (double) (value 9999=not measured)
0x04	101	uInt16	All outputs current [mA]
0x04	102	uInt16	1st output current [mA]
0x04	103	uInt16	2nd output current [mA]
0x04	104	uInt16	3rd output current [mA]
0x04	105	uInt16	4th output current [mA]
0x04	201	uInt16	All outputs power [W]
0x04	202	uInt16	1st output power [W]
0x04	203	uInt16	2nd output power [W]
0x04	204	uInt16	3rd output power [W]
0x04	205	uInt16	4th output power [W]

0x04	301	uInt16	All outputs energy counter - 2 upper bytes [Wh]
0x04	302	uInt16	All outputs energy counter - 2 lower bytes [Wh]
0x04	303	uInt16	1st output energy counter - 2 upper bytes [Wh]
0x04	304	uInt16	1st output energy counter - 2 lower bytes [Wh]
0x04	305	uInt16	2nd output energy counter - 2 upper bytes [Wh]
0x04	306	uInt16	2nd output energy counter - 2 lower bytes [Wh]
0x04	307	uInt16	3rd output energy counter - 2 upper bytes [Wh]
0x04	308	uInt16	3rd output energy counter - 2 lower bytes [Wh]
0x04	309	uInt16	4th output energy counter - 2 upper bytes [Wh]
0x04	310	uInt16	4th output energy counter - 2 lower bytes [Wh]
0x04	401	uInt16	All outputs TPF [1/1000]
0x04	402	uInt16	1st output TPF [1/1000]
0x04	403	uInt16	2nd output TPF [1/1000]
0x04	404	uInt16	3th output TPF [1/1000]
0x04	405	uInt16	4th output TPF [1/1000] (value 9999=not measured)
0x04	501	Int16	All outputs Phase shift [1/10°]
0x04	502	Int16	1st output Phase shift [1/10°]
0x04	503	Int16	2nd output Phase shift [1/10°]
0x04	504	Int16	3rd output Phase shift [1/10°]
0x04	505	Int16	4th output Phase shift [1/10°] (value 9999=not measured)
0x04	601	uInt16	All out. reverseEnergy counter - 2up.bytes [Wh]
0x04	602	uInt16	All out. reverseEnergy counter - 2lo.bytes [Wh]
0x04	603	uInt16	1st out. reverseEnergy counter - 2up.bytes [Wh]
0x04	604	uInt16	1st out. reverseEnergy counter - 2lo.bytes [Wh]
0x04	605	uInt16	2nd out. reverseEnergy counter - 2up.bytes [Wh]
0x04	606	uInt16	2nd out. reverseEnergy counter - 2lo.bytes [Wh]
0x04	607	uInt16	3rd out. reverseEnergy counter - 2up.bytes [Wh]
0x04	608	uInt16	3rd out. reverseEnergy counter - 2lo.bytes [Wh]
0x04	609	uInt16	4th out. reverseEnergy counter - 2up.bytes [Wh]
0x04	610	uInt16	4th out. reverseEnergy counter - 2lo.bytes [Wh]
0x04	1001	uInt16	All outputs energy NR counter - 2 upper bytes [Wh]
0x04	1002	uInt16	All outputs energy NR counter - 2 lower bytes [Wh]
0x04	1003	uInt16	1st output energy NR counter - 2 upper bytes [Wh]
0x04	1004	uInt16	1st output energy NR counter - 2 lower bytes [Wh]
0x04	1005	uInt16	2nd output energy NR counter - 2 upper bytes [Wh]
0x04	1006	uInt16	2nd output energy NR counter - 2 lower bytes [Wh]
0x04	1007	uInt16	3rd output energy NR counter - 2 upper bytes [Wh]
0x04	1008	uInt16	3rd output energy NR counter - 2 lower bytes [Wh]
0x04	1009	uInt16	4th output energy NR counter - 2 upper bytes [Wh]
0x04	1010	uInt16	4th output energy NR counter - 2 lower bytes [Wh]
0x04	1101	uInt16	All out. reverseEnergy NR counter - 2up.bytes [Wh]
0x04	1102	uInt16	All out. reverseEnergy NR counter - 2lo.bytes [Wh]
0x04	1103	uInt16	1st out. reverseEnergy NR counter - 2up.bytes [Wh]
0x04	1104	uInt16	1st out. reverseEnergy NR counter - 2lo.bytes [Wh]
0x04	1105	uInt16	2nd out. reverseEnergy NR counter - 2up.bytes [Wh]
0x04	1106	uInt16	2nd out. reverseEnergy NR counter - 2lo.bytes [Wh]

0x04	1107	uInt16	3rd out. reverseEnergy NR counter - 2up.bytes [Wh]
0x04	1108	uInt16	3rd out. reverseEnergy NR counter - 2lo.bytes [Wh]
0x04	1109	uInt16	4th out. reverseEnergy NR counter - 2up.bytes [Wh]
0x04	1110	uInt16	4th out. reverseEnergy NR counter - 2lo.bytes [Wh]
0x05	102	0/1	Turn On/Off 1st output (Write)
0x05	103	0/1	Turn On/Off 2nd output
0x05	104	0/1	Turn On/Off 3rd output
0x05	105	0/1	Turn On/Off 4th output
0x06	102	uInt16	Set action to 1st output
0x06	103	uInt16	Set action to 2nd output
0x06	104	uInt16	Set action to 3rd output
0x06	105	uInt16	Set action to 4th output
0x06	202	uInt16	Set "Short" delay of 1st output [1/10sec]
0x06	203	uInt16	Set "Short" delay of 2nd output [1/10sec]
0x06	204	uInt16	Set "Short" delay of 3rd output [1/10sec]
0x06	205	uInt16	Set "Short" delay of 4th output [1/10sec]

For more information about the M2M Modbus/TCP protocol, visit the **Support > Download** section of our website and see the following document:

[Modbus / TCP - description of NETIO M2M API interface - PDF](#)

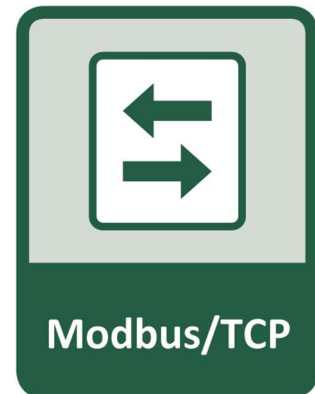

For more information and a practical demonstration of using the Modbus/TCP protocol with NETIO smart sockets, see the following Application Note:

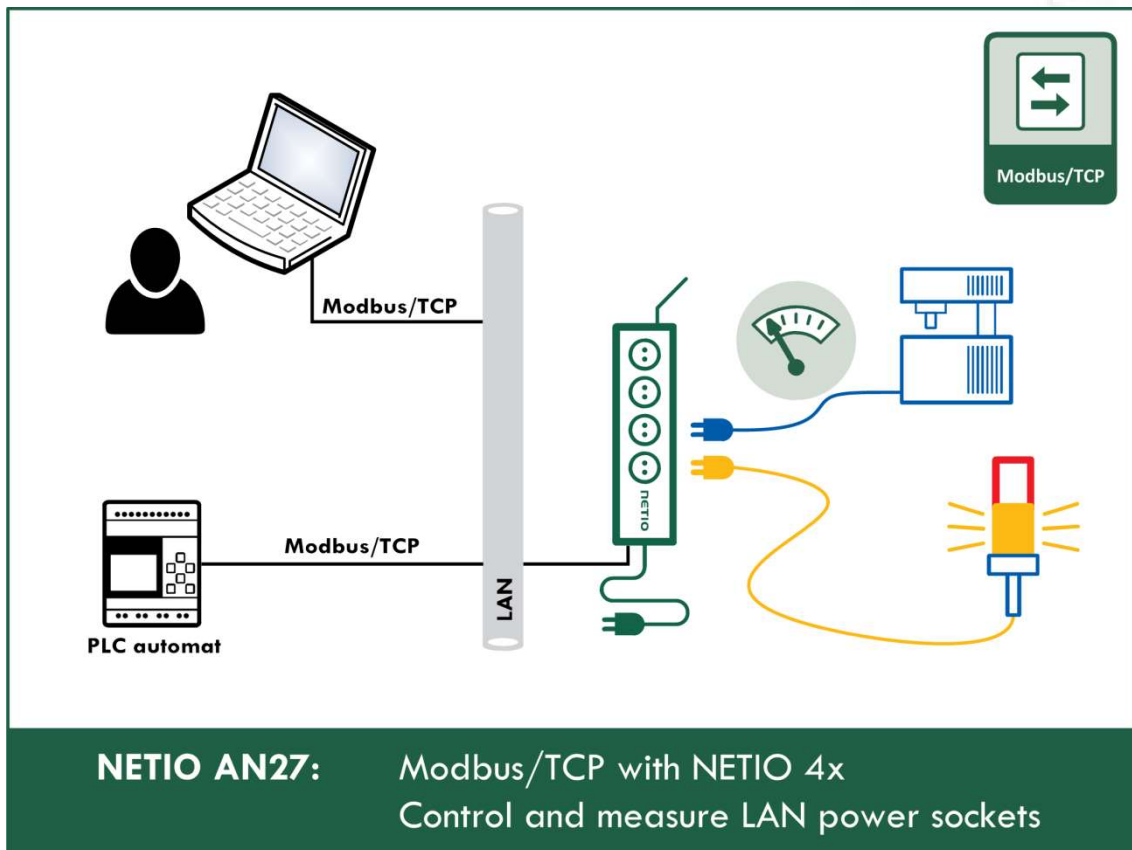
AN27: Modbus/TCP with NETIO 4x - Control and measure LAN power sockets

5.2.6 M2M API Protocol - MQTT-flex

The screenshot shows the PowerBOX 4KE web interface. The browser address bar displays `192.168.64.12/#/interfaces/108`. The page title is "PowerBOX 4KE" and the user is logged in as "admin". The left sidebar contains a menu with "M2M API Protocols" selected. The main content area shows the MQTT-flex configuration page. At the top, there is a checkbox labeled "Enable MQTT-flex" which is checked. Below it, there is a text area for the MQTT-flex configuration (max 6000 characters). The configuration is a JSON object with the following structure:

```

1  {
2  "broker": {
3    "clientid": "netio${DEVICE_SN}",
4    "keepalive": 30,
5    "password": "",
6    "port": 1883,
7    "protocol": "mqtt",
8    "ssl": false,
9    "type": "generic",
10   "url": "broker.hivemq.com",
11   "username": ""
12  },
13  "publish": [
14    {
15     "events": [
16     {
17       "source": "OUTPUTS/1/STATE",
18       "type": "change"
19     },
20     {
21       "source": "OUTPUTS/2/STATE"

```

At the bottom of the configuration area, there is a green "Save Changes" button. Below the button, there is a link to the "MQTT-flex - Online Configuration Manual".

Figure 30 - MQTT-flex protocol configuration

Enable MQTT-flex

Enables MQTT-flex functions in the system.

MQTT-flex Config:

Text area for entering the MQTT-flex configuration.

Save Changes

Saves the changes.

When the MQTT-flex is enabled, other M2M protocols are disabled except SNMP. After clicking **Save changes**, the notification message about the deactivation of the other protocol appears.

NETIO device uses json to define the MQTT-flex structure (MQTT-flex Config). Both subscribe and publish topics can be defined. Publish topics may include actions that initiate a transmission.

MQTT-flex configuration example:

```
{
  "broker": {
    "clientid": "netio${DEVICE_SN}",
    "keepalive": 30,
    "password": "",
    "port": 1883,
    "protocol": "mqtt",
    "ssl": false,
    "type": "generic",
    "url": "broker.hivemq.com",
    "username": ""
  },
  "publish": [
    {
      "events": [
        {
          "source": "OUTPUTS/1/STATE",
          "type": "change"
        },
        {
          "source": "OUTPUTS/2/STATE",
          "type": "change"
        },
        {
          "source": "OUTPUTS/3/STATE",
          "type": "change"
        },
        {
          "source": "OUTPUTS/4/STATE",
          "type": "change"
        },
        {
          "delta": 200,
          "source": "OUTPUTS/1/CURRENT",
          "type": "delta"
        },
        {
          "delta": 200,
          "source": "OUTPUTS/2/CURRENT",
          "type": "delta"
        },
        {
          "period": 3600,
          "type": "timer"
        }
      ],
      "payload": "${INOUT_STATUS}",
      "qos": 0,
      "retain": false,
      "topic": "devices/${DEVICE_NAME}/messages/devicebound/"
    }
  ],
}
```

```

"subscribe": [
  {
    "action": "${payload}",
    "qos": 0,
    "target": "REST_JSON",
    "topic": "devices/${DEVICE_NAME}/messages/events/"
  }
]
}

```

For more information about the M2M MQTT-flex API, visit the **Support > Download** section of our website and see the following document:

[MQTT-flex - description of NETIO M2M API interface - PDF](#)

There are wide options for subscribe and publish sections and its possibilities expand over the time.

You will find details and examples at our online resource center: <https://wiki.netio-products.com/index.php?title=MQTT-flex>

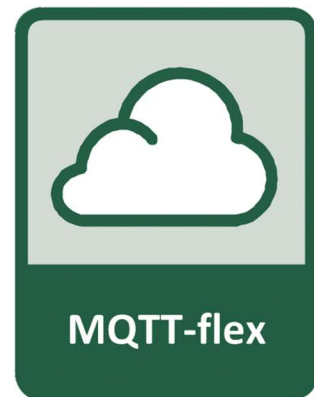

For more information and a practical demonstration of using the MQTT protocol with NETIO smart sockets, see the following Application Note:

[AN40 Getting started with PowerCable MQTT-flex via HiveMQ MQTT broker to mobile App](#)

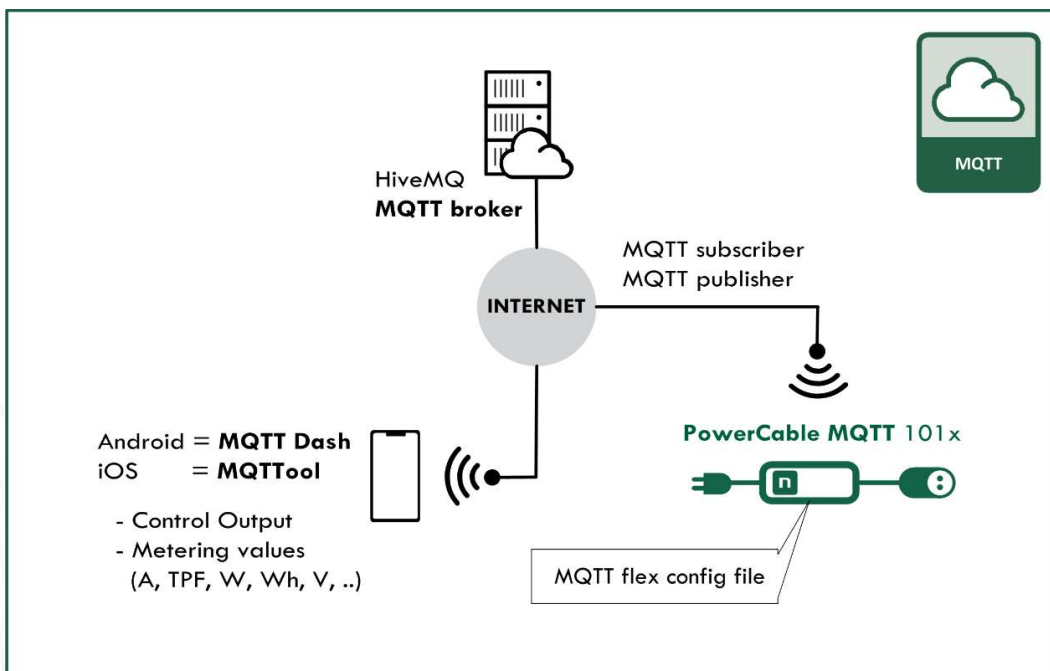

NETIO AN40: Getting started with PowerCable MQTT-flex via HiveMQ MQTT broker to mobile App.

5.2.7 M2M API Protocol - Netio Push

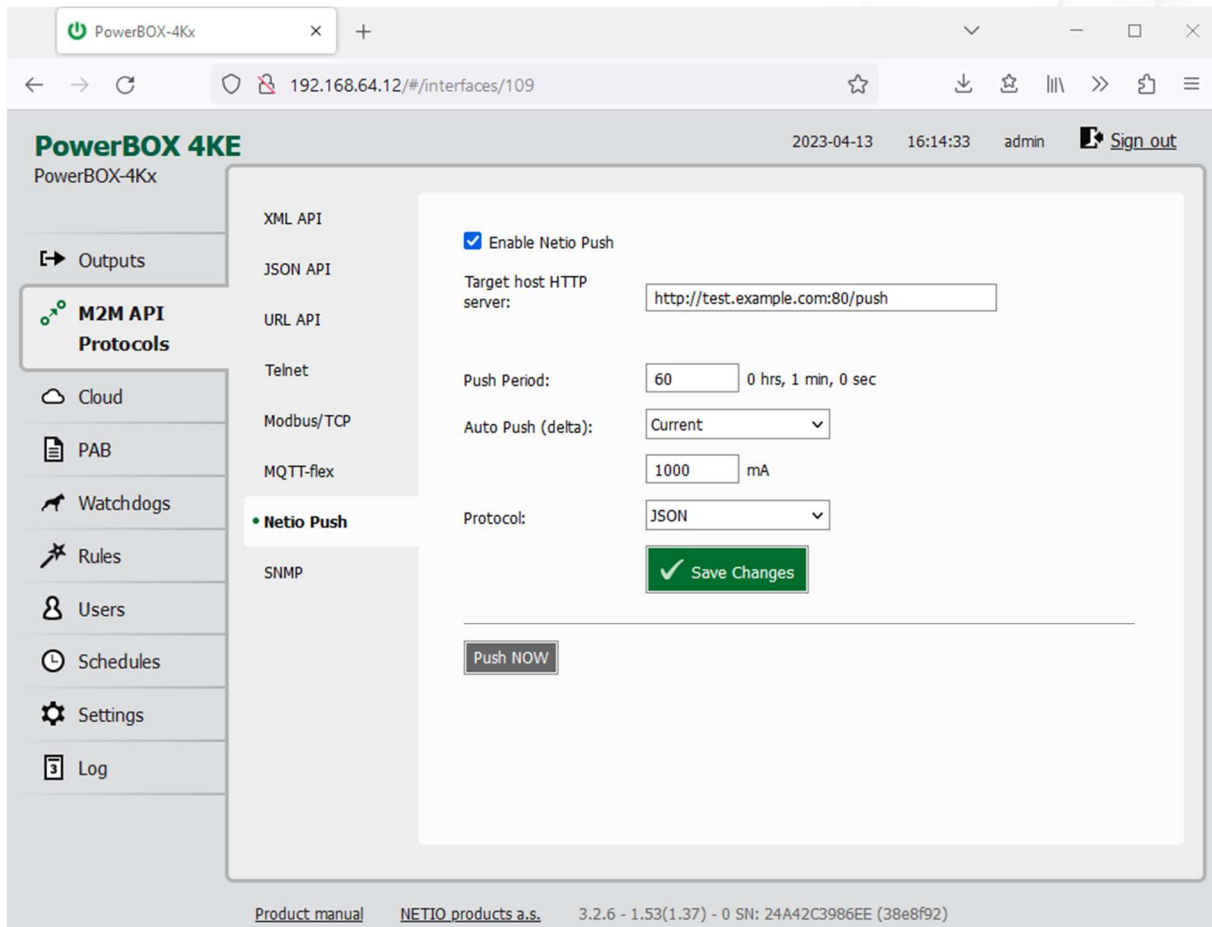

Figure 31 - Netio Push protocol configuration

Enable Netio Push

Enables Netio Push functions in the system.

Target host HTTP server:

Defines the parameters of the target:

- http / https to specify the protocol
- Target URL
- Port
- Username and Password

Example: `https://username:password@test.example.com:80/push`

Push Period

Period for the automatic sending of data (Push), in seconds.

Auto Push (delta)

Data will be immediately sent (Push) if a measured value exceeds this limit.

Parameter - at this time, only Current

Value - limit value for the selected parameter

Protocol

Selects the payload format.

- JSON
- XML

Save Changes

Saves the changes.

When the Netio Push is enabled, other M2M protocols are disabled except SNMP. After clicking **Save changes**, the notification message about the deactivation of the other protocol appears.

Data (payload - JSON/XML) are automatically periodically sent to the target address using HTTP(s), depending on the configured push period.

Output control over the NETIO PUSH - JSON

Device is periodically connecting to the Target host http(s) server within push period (default 60seconds). It means the output can be switched only when the TCP/IP connection is established. In default once every 60 seconds.

If the response from Target host is error code 200 (OK) and the payload contains valid NETIO JSON structure with control command then the Output will be set accordingly. This way is possible to control device even if this is in private network behind NAT.

The NETIO JSON structure is described in section [M2M API Protocol - JSON \(REST M2M API\)](#).

For more information about the M2M HTTP(s) Push API, visit the **Support > Download** section of our website and see the following document:

[HTTP\(s\) Push JSON - description of NETIO M2M API interface - PDF](#)



5.2.8 M2M API Protocol - SNMP

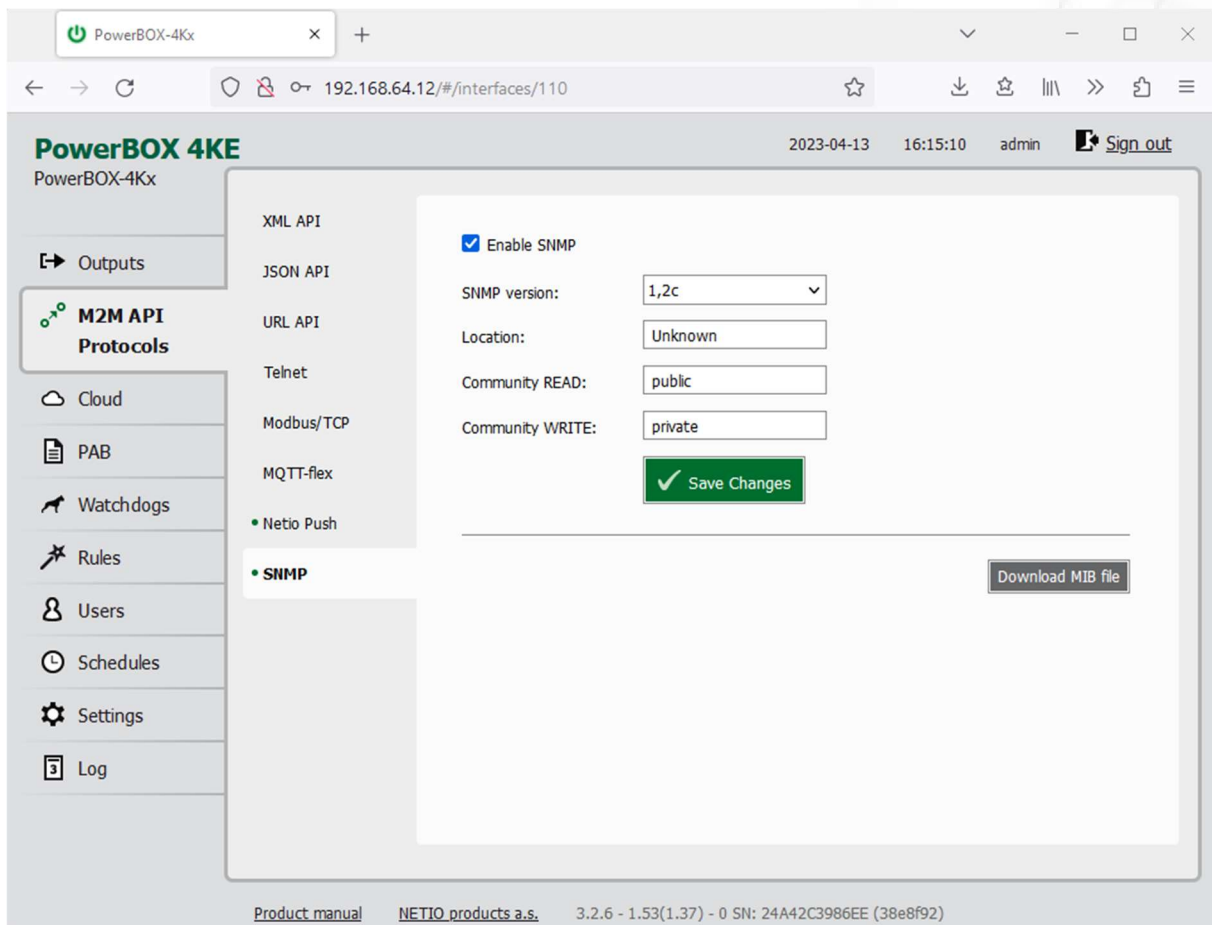

Figure 32 - SNMP API protocol configuration

Enable SNMP

Enables M2M SNMP API functions in the system.
The port is 161.

SNMP version

1,2c - unsecured, unencrypted
3 - secured

Location

Define system location (sysLocation).

Community READ (v1,2 only)

Also called the “community string” in SNMP. Similar to a username/password combination. Needed for **reading** information from NETIO device over SNMP.

We recommend to use “pure” ASCII characters (that is, to avoid accented and special characters, such as @, & and so on, if possible).

Community WRITE (v1,2 only)

Also called the “community string” in SNMP. Similar to a username/password combination. Needed for **writing** commands to NETIO device over SNMP.

We recommend to use “pure” ASCII characters (that is, to avoid accented and special characters, such as @, & and so on, if possible).

Security name (v3 only)

A string representing the name of the user.

Security level (v3 only)

authPriv / authNoPriv / noAuthNoPriv

Auth protocol (v3 only)

Authentication Protocol - An indication of whether messages sent on behalf of this user can be authenticated, and if so, the type of authentication protocol used.

This can take one of the two values: SHA / MD5

Auth key (v3 only)

Authentication protocol password - The (private) authentication key for use with the authentication protocol. This is a string password for MD5 or SHA depending on the choice above.

Priv protocol (v3 only)

Privacy protocol - An indication of whether messages sent on behalf of this user can be protected from disclosure, and if so, the type of privacy protocol which is used. This takes the value AES (DES not supported).

Priv key (v3 only)

Privacy protocol password. If messages sent on behalf of this user can be encrypted/decrypted with AES, the (private) privacy key for use with the privacy protocol.

Save Changes

Saves the changes.

Download MIB file

Use this button to download MIB.

The MIB can be downloaded from a device web administrator as described above.

Following standard MIBs are also required:

- SNMPv2-SMI
- SNMPv2-TC

Monitoring (read)

x = Output/Input number

Object OID	Type	Value example	Note
netioOutputID.x.0 1.3.6.1.4.1.47952.1.1.1.1.x.0	INTEGER	1	
netioOutputName.x.0 1.3.6.1.4.1.47952.1.1.1.2.x.0	STRING	output_1	Based on user defined name
netioOutputState.x.0 1.3.6.1.4.1.47952.1.1.1.3.x.0	INTEGER	off(0), on(1)	
netioOutputStateString.x.0 1.3.6.1.4.1.47952.1.1.1.4.x.0	STRING	"off", "on"	
netioOutputLoad.x.0 1.3.6.1.4.1.47952.1.1.1.25.x.0	INTEGER	24	[W]
netioOutputEnergy.x.0 1.3.6.1.4.1.47952.1.1.1.26.x.0	INTEGER	13	[Wh]
netioOutputEnergyStart.x.0 1.3.6.1.4.1.47952.1.1.1.27.x.0	DateAnd Time	2017-6- 23,5:47:3.0,+ 0:0	Initial date and time. UTC based
netioOutputCurrent.x.0 1.3.6.1.4.1.47952.1.1.1.28.x.0	INTEGER	195	[mA]

netioOutputPowerFactor.x.0 1.3.6.1.4.1.47952.1.1.1.29.x.0	INTEGER	534	Current power factor * 1000
netioOutputPhase.x.0 1.3.6.1.4.1.47952.1.1.1.30.x.0	INTEGER	31683	[°] * 100
netioOutputReverseEnergy.x.0 1.3.6.1.4.1.47952.1.1.1.31.x.0	INTEGER	4747	[Wh]
netioOutputEnergyNR.x.0 1.3.6.1.4.1.47952.1.1.1.32.x.0	INTEGER	4093	[Wh]
netioOutputReverseEnergyNR.x.0 1.3.6.1.4.1.47952.1.1.1.33.x.0	INTEGER	6751	[Wh]
netioVoltage.0 1.3.6.1.4.1.47952.1.2.1.0	INTEGER	239100	Voltage in the power grid [mV]
netioFrequency.0 1.3.6.1.4.1.47952.1.2.2.0	INTEGER	49900	Frequency in the power grid [mHz]
netioTotalCurrent.0 1.3.6.1.4.1.47952.1.2.3.0	INTEGER	195	[mA]
netioOverallPowerFactor.0 1.3.6.1.4.1.47952.1.2.4.0	INTEGER	534	Total TPF *1000 <i>Not available in PowerBOX 4Kx</i>
netioTotalLoad.0 1.3.6.1.4.1.47952.1.2.5.0	INTEGER	24	Total Load [W]
netioTotalEnergy.0 1.3.6.1.4.1.47952.1.2.6.0	INTEGER	13	Total Energy [Wh]
netioEnergyStart.0 1.3.6.1.4.1.47952.1.2.7.0	DateAnd Time	2017-6-23,5:47:3.0,+0:0	Initial date and time. UTC based
netioTotalPhase.0 1.3.6.1.4.1.47952.1.2.8.0	INTEGER	27581	Total Phase * 100 [°] <i>Not available in PowerBOX 4Kx</i>
netioTotalReverseEnergy.0 1.3.6.1.4.1.47952.1.2.9.0	INTEGER	6664	Total Reverse Energy [Wh]
netioTotalEnergyNR.0 1.3.6.1.4.1.47952.1.2.10.0	INTEGER	72987	[Wh]
netioTotalReverseEnergyNR.0 1.3.6.1.4.1.47952.1.2.11.0	INTEGER	8877	[Wh]

Control (write)

x = Output number

Object OID	Type	Value	Action
netioOutputAction.x.0 1.3.6.1.4.1.47952.1.1.1.5.x.0	INTEGER (i)	0 1 2 3 4 5	Turn OFF Turn ON Short OFF delay (restart) Short ON delay Toggle (invert the state) No change

For more information about the M2M SNMP API, visit the [Support > Download](#) section of our website and see the following document:

[SNMP API - description of NETIO M2M API interface - PDF](#)

Note: There are differences compare to description in PDF:

- PowerBOX can be controlled over SNMP v1/2c
- All Objects/OIDs have added “.0” at the end (the tables on previous page contain correct/full Objects/OIDs).

Please contact NETIO support in case of questions.

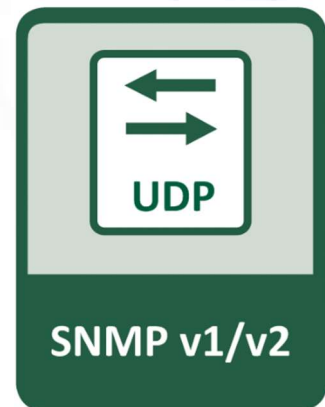

For more information and a practical demonstration of using the SNMP protocol with NETIO smart sockets, see the following Application Note:

[SNMP management of 110/230V power outlets from the command line in Windows and Linux](#)

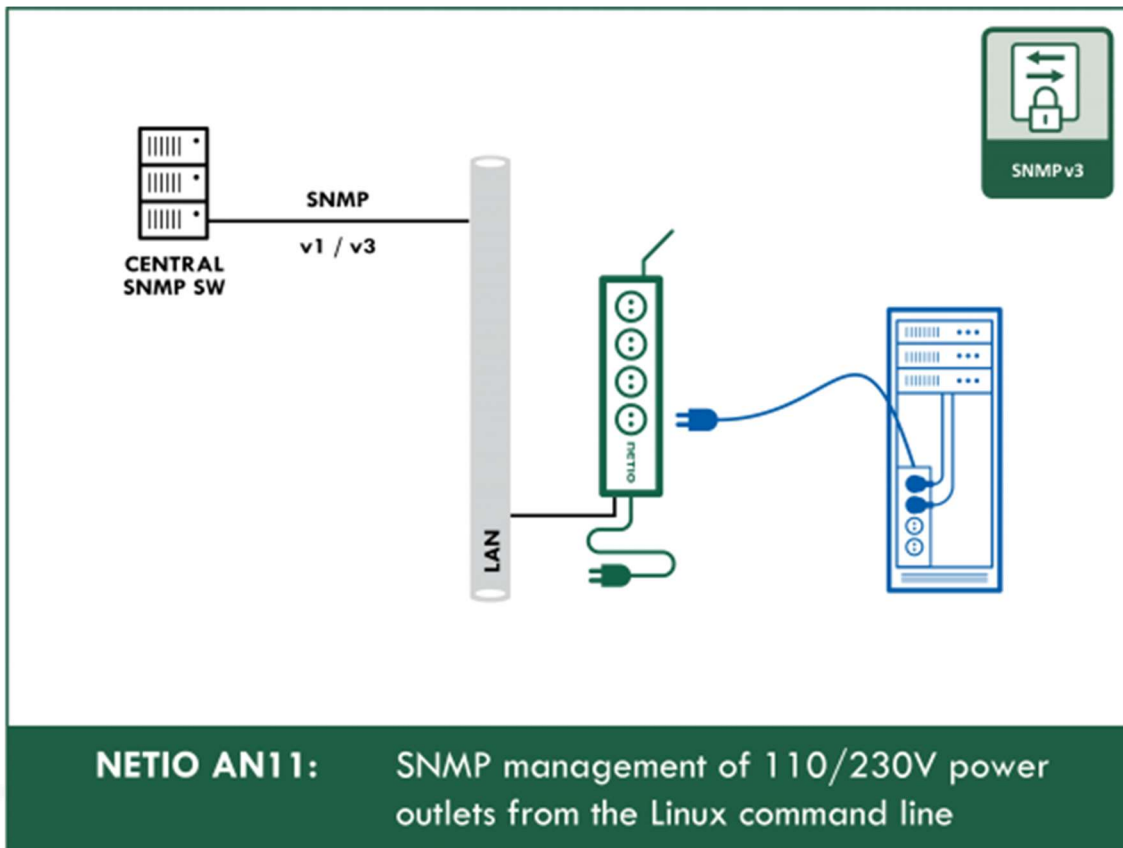

5.3 Cloud

Netio Cloud is a service provided by NETIO Products a.s. and allow easy central remote control and monitoring of the NETIO devices. What can you do in NETIO Cloud?

Output control

- On/Off switch.
- Reset button (Short Off for defined time).
- Show power consumption [kWh] per output (metered device only)

Settings

- Output name can be modified.
- Outputs can be placed to any of groups.
- Short OFF (restart) interval for reset can be set up.

NETIO Cloud is a paid service, but the current customers will gain some free credits with each device added to their NETIO Cloud account.

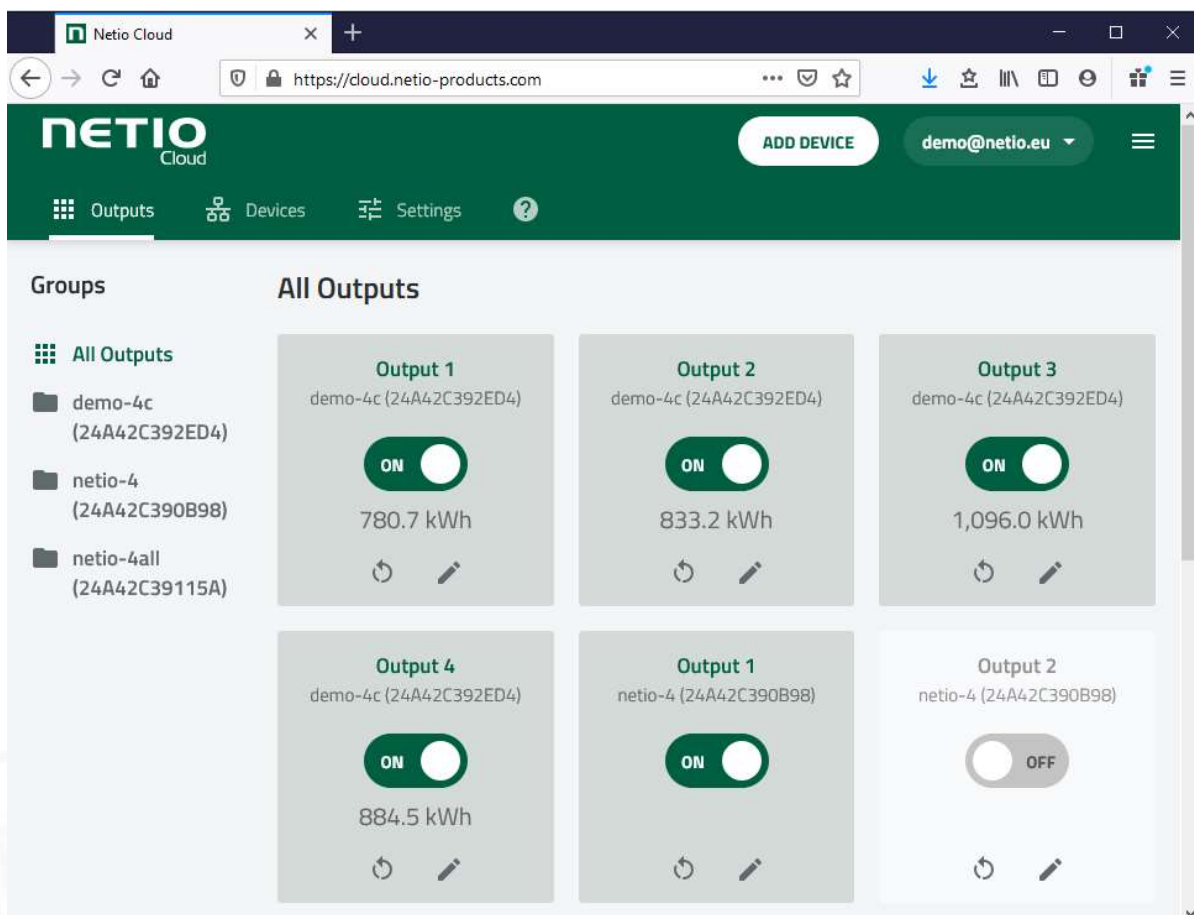

Figure 33 - NETIO Cloud

Connection to NETIO Cloud can be configured on Cloud tab.

Figure 34 - Cloud configuration

Enable NETIO Cloud

Check to enable NETIO Cloud.

Status

Off: NETIO Cloud disabled

Disconnected: Device not connected to Cloud

Cloud connect failed...reconnecting: Device is trying to connect to Cloud.

Connected: Device connected to NETIO Cloud.

Connected and synchronized: Device connected to NETIO Cloud and account information synchronized.

Last update

Date and time of the last update.

Added to account

Account name to what this device is assigned.

<i>Device UID</i>	Unique device ID.
<i>Save Changes</i>	Saves the changes.
<i>Registration token</i>	Enter the registration token from NETIO Cloud web - shown when "ADD DEVICE" button used. Then press "Add device" button.
<i>Remove device</i>	If this device is connected to NETIO Cloud use this button to remove/disconnect it from NETIO Cloud.
<i>Account info</i>	Use "Reload" button tu refresh account information.
<i>Credit</i>	Value of the available credit for Cloud account.
<i>Account log</i>	Log of the Cloud account events.

5.4 PAB

The PAB (Power Analysis Block) is **Condition & Rules (C&R)** function available for NETIO devices that periodically evaluates sets of conditions. Based on these conditions, subsequent **Rules** can be executed. These conditions can consist of one or more of following variables:

Current [mA], Energy [Wh], Load [W], Power Factor, S0 pulses

Several PAB's can be configured and running simultaneously.

You will find details and examples at our online resource center:

<https://wiki.netio-products.com/index.php?title=PAB>

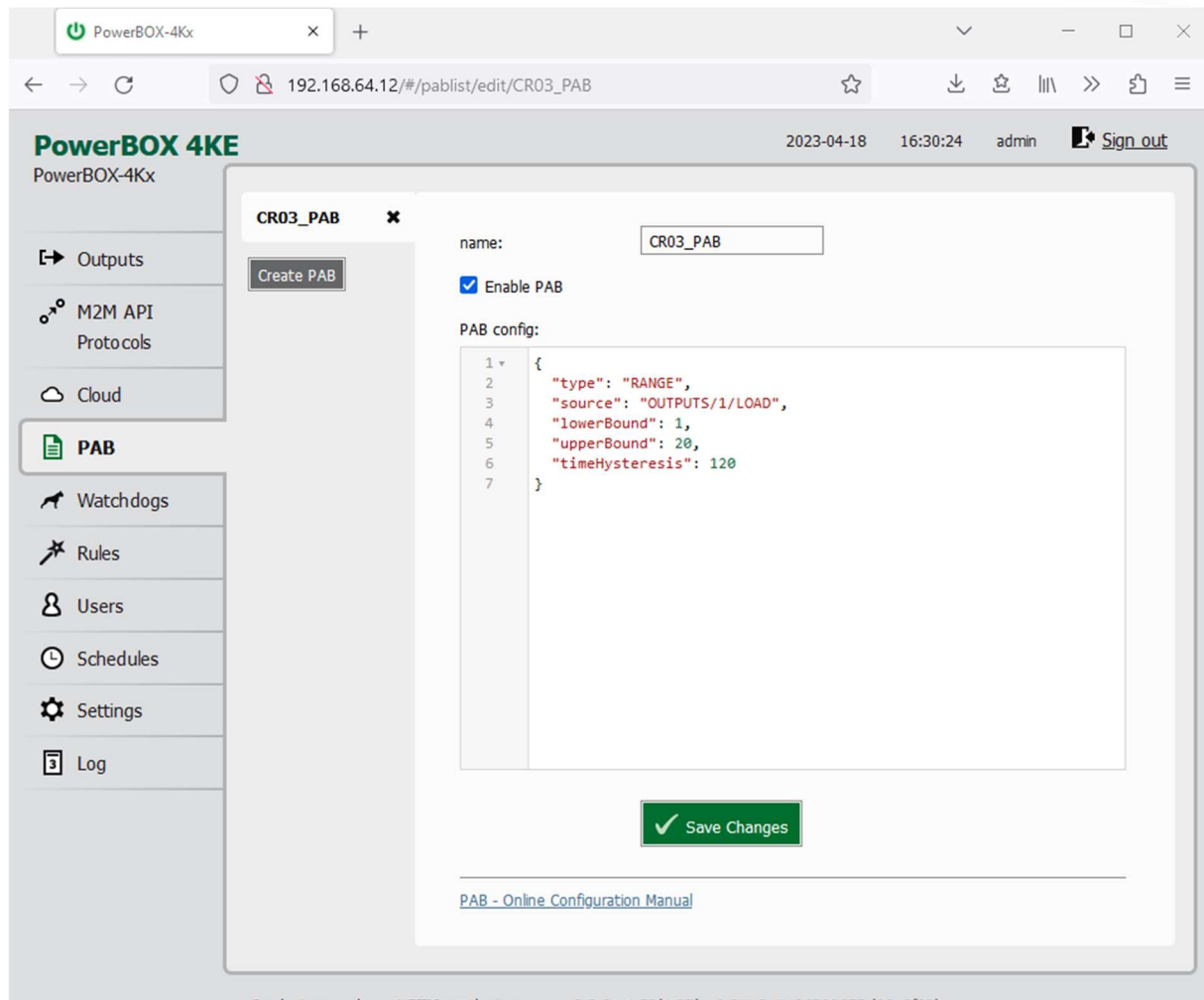

Figure 35 - PAB configuration

name	The name of PAB configuration.
Enable PAB	Check to enable this PAB
PAB config	PAB configuration.
Save Changes	Saves the changes.
Create PAB	Opens a dialog to enter the new PAB configuration.

5.5 Watchdogs

Watchdog is a **Condition & Rules** function periodically pinging to one defined IP address or URL. It's periodically checking reply from defined IP device by ping (ICMP). You can monitor physical presence of the IP device or Internet connectivity. You can use several WatchDog functions in parallel.

Based on each Watchdog state one or several **Rules** can be executed. Each Rule can perform several actions (Set Output, Short Off (restart) output, Toggle output or send Alarm state to the NETIO Cloud service. Based on this Alarm state can NETIO Cloud send email to defined recipient. All Watchdogs are listed in the JSON protocol with their current states. It can be used by 3rd party software.

Each Watchdog function state is the FAIL variable.

- Watchdog Fail = FALSE = ping answer is OK
- Watchdog Fail = TRUE = ping answer not received

Several Watchdogs can be configured and running simultaneously.

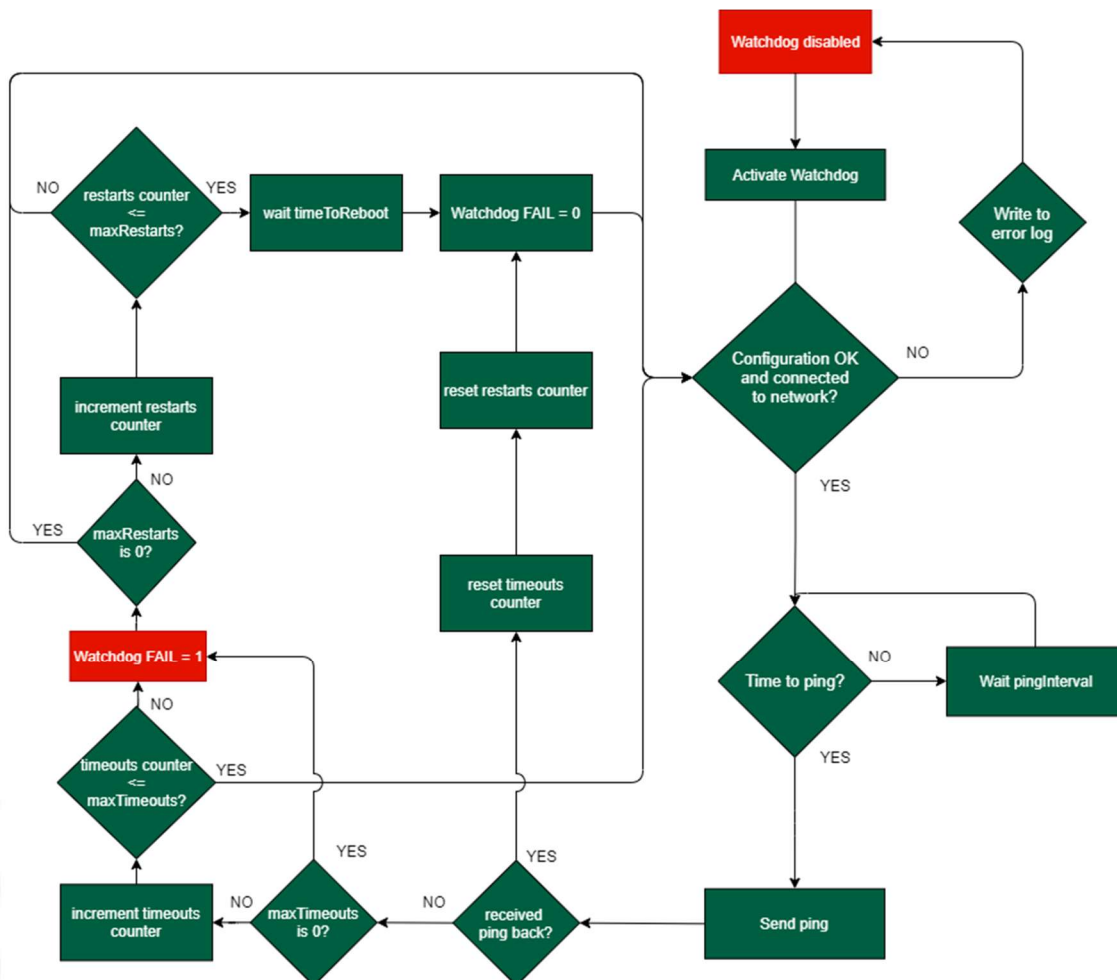

Figure 36 - Watchdogs flow diagram

You will find details and examples at our online resource center:

<https://wiki.netio-products.com/index.php?title=Watchdog>

Figure 37 - Watchdogs configuration

name	The name of Watchdog configuration.
Enable Watchdog	Check to enable this Watchdog
Watchdog config	Watchdog configuration.
Save Changes	Saves the changes.
Create Watchdog	Opens a dialog to enter the new Watchdog configuration.

5.6 Rules

Rules are active part of the **Condition & Rules** functions.

Each Rule define the follow-up actions based on current [PAB](#) / [Watchdog](#) function state. There can be several Rules executed based on one PAB function (switch output if Current > 1000 mA + Send Alert to NETIO Cloud IF Current > 500 mA). One Rule can be executed based on combination of several PAB / WatchDog states.

You will find details and examples at our online resource center:

<https://wiki.netio-products.com/index.php?title=Rules>

The screenshot shows the 'Rules' configuration page in the PowerBOX 4KE web interface. The page title is 'PowerBOX 4KE' and the user is logged in as 'admin'. The left sidebar contains navigation options: Outputs, M2M API Protocols, Cloud, PAB, Watchdogs, Rules (selected), Users, Schedules, Settings, and Log. The main content area shows a list of rules (Rule1, Rule2, Rule3) and a 'Create Rule' button. The configuration for Rule1 is displayed, including a name field, an 'Enable rule' checkbox, and a JSON rule configuration. The configuration includes conditions for 'PAB/PAB_RANGE_1/IN' and actions for 'OUTPUTS/1/ACTION' and 'CLOUD/OUTPUT/1/ALARM'. A 'Save Changes' button is visible at the bottom of the configuration area.

Figure 38 - Rules configuration

name	The name of Rule configuration.
Enable Rule	Check to enable this Rule
Rule config	Rule configuration.
Save Changes	Saves the changes.
Create Rule	Opens a dialog to enter the new Rule configuration.

5.7 Users

When several users use the NETIO device, it is advisable to assign them different accounts with the necessary privileges. In the left menu, select **Users**.

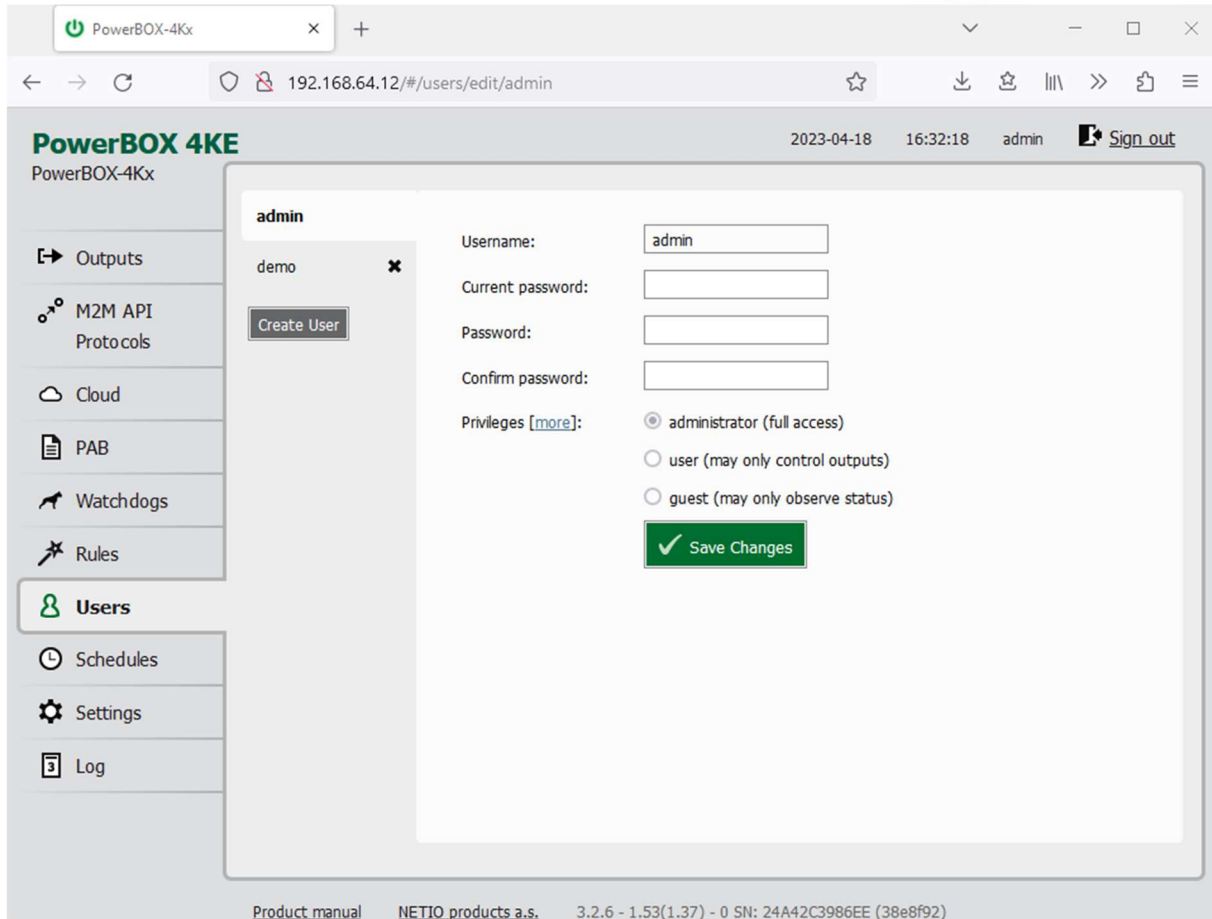

Figure 39 - Adding and managing users

Username	The username. The NETIO device must always have an “admin” account with administrator privileges; this account cannot be deleted or disabled. The device supports up to 5 user accounts. The username must start with a letter and may only contain numbers and letters without accents.
Current password	When changing the password, the current (old) password must be entered.
Password	New password for the given account. The password can be up to 15 characters long and may consist of alphanumeric characters and the following special characters: <code>_ ; ! * () { } [] # \$ % @ ^ + - ~</code>
Confirm password	Enter the password again.
Privileges	administrator (full access): User with full privileges.

user (may only control outputs): User that can control the outputs but cannot change system settings.

guest (may only observe status): User that cannot change any settings, may only monitor the current output state.

Click “more/less” to display detailed privileges.

<i>Create User</i>	Opens a dialog to enter the parameters of a new user account.
<i>Save changes or Create User</i>	Saves the changes.

Only an administrator or a user with the “manage users” privilege may change the passwords of other users.

Note: User based account can be used for access to NETIO Mobile2 App.

5.8 Schedules

Schedules can specify when should an output be switched on or when is an action valid. To manage schedules, select **Schedules** in the left menu.

By default, NETIO PowerBOX contains one schedule: **Always**. To create a new schedule, click **Create schedule**. Specify the schedule name and set the intervals when the output should be switched on.

Note

For an output to be controlled according to the schedule, the schedule needs to be selected for that particular output at the [Schedule](#) tab in the output configuration.

PowerBOX 4KE

2023-04-18 16:33:23 admin Sign out

Workday ✕

Test ✕

Create Schedule

Name: Workday

	All day	3:00	6:00	9:00	12:00	15:00	18:00	21:00
Monday								09:00 – 21:00
Tuesday								09:00 – 21:00
Wednesday								09:00 – 21:00
Thursday								09:10 – 21:00
Friday								09:00 – 21:00
Saturday								
Sunday								

Save Changes

The changes of Schedule apply after the next planned change or when Schedule will be enabled for a specific output.

Product manual NETIO products a.s. 3.2.6 - 1.53(1.37) - 0 SN: 24A42C3986EE (38e8f92)

Figure 40 - Adding a custom schedule

A new interval can be quickly created by marking the corresponding slots by clicking and dragging with the **left** mouse button. An existing interval can be shortened or extended by dragging either end of the interval. To delete an interval, click it with the **right** mouse button. To create an interval encompassing an entire day, click the box next to that day in the **All day** column. By clicking and dragging, intervals (including all-day ones) can be created for several days at the same time.

In this quick way, intervals can be created with a granularity of 10 minutes. To specify the times for an existing interval more precisely, click it with the left mouse button to open the start and end time settings. There it is possible to specify the time up to the second. To save the new values, click **OK**. To create a new interval by entering the precise times, click an empty space within the respective day with the **left** mouse button.

The screenshot shows the PowerBOX 4KE web interface. The browser address bar displays `192.168.64.12/#/schedules/create`. The page title is "PowerBOX 4KE" and the user is logged in as "admin". The left sidebar contains navigation options: Outputs, M2M API Protocols, Cloud, PAB, Watchdogs, Rules, Users, Schedules (selected), Settings, and Log. The main content area shows the "Create Schedule" form with a "Name" field containing "new". A modal dialog titled "Add interval" is open, with "From:" set to "03:00" and "To:" set to "03:10". The dialog has "OK" and "Cancel" buttons. The background shows a schedule grid with columns for "All day", "3:00", "6:00", "9:00", "12:00", "15:00", "18:00", and "21:00".

Figure 41 - Adding an interval with a precision to the second



Deleting a schedule

By deleting a schedule, all Schedulers for specific outputs with this schedule are automatically disabled. The states of the respective outputs are unchanged; however, from that moment on, the outputs are under manual control.

5.9 Settings

NETIO PowerBOX can use the Ethernet connection (RJ45).

To ensure correct operation as intended, the device settings need to be properly configured. Select **Settings** in the left menu to display a sub-menu with product settings.

5.9.1 Network Configuration

This section allows configuring the IP parameters of the PowerDIN 4PZ network interface, which are essential for correct network operation. One of the options Wi-Fi / Ethernet or both can be configured depending on chosen connectivity.

Figure 42 - Network configuration - Ethernet

MAC address	Ethernet address of the Ethernet network adapter. Unique for each device. Also] corresponds to the NETIO device serial number.
Status	Connection status
Use DHCP	When selected, the device attempts to obtain network configuration from a DHCP server. If your network does not use DHCP, set the parameters statically.

Set static IP address

Manual configuration of network parameters. Select this option if your network does not have a DHCP server.

IP address	Choose an unused IP address in your network's address range.
Net mask	Set the network mask according to your network's address range.
Default gateway	Address of the network gateway. Corresponds to the address of your router's LAN interface.
DNS server	IP address of the domain name server. It is usually the same as the gateway address, as long as the DNS function is enabled on the router. If unsure, enter a public DNS server, such as: 8.8.8.8
Hostname	Name of the device in the local network. It is generated from the Device name (unsupported characters are replaced).
Save Changes	Saves the changes.

**Caution**

After changing the network configuration, it may be necessary to re-discover the NETIO device at its new address. The discovery procedure is described in section [Detecting and configuring the IP address](#) .

5.9.2 Date / Time

In the Settings menu on the left, select  **Date/Time**.

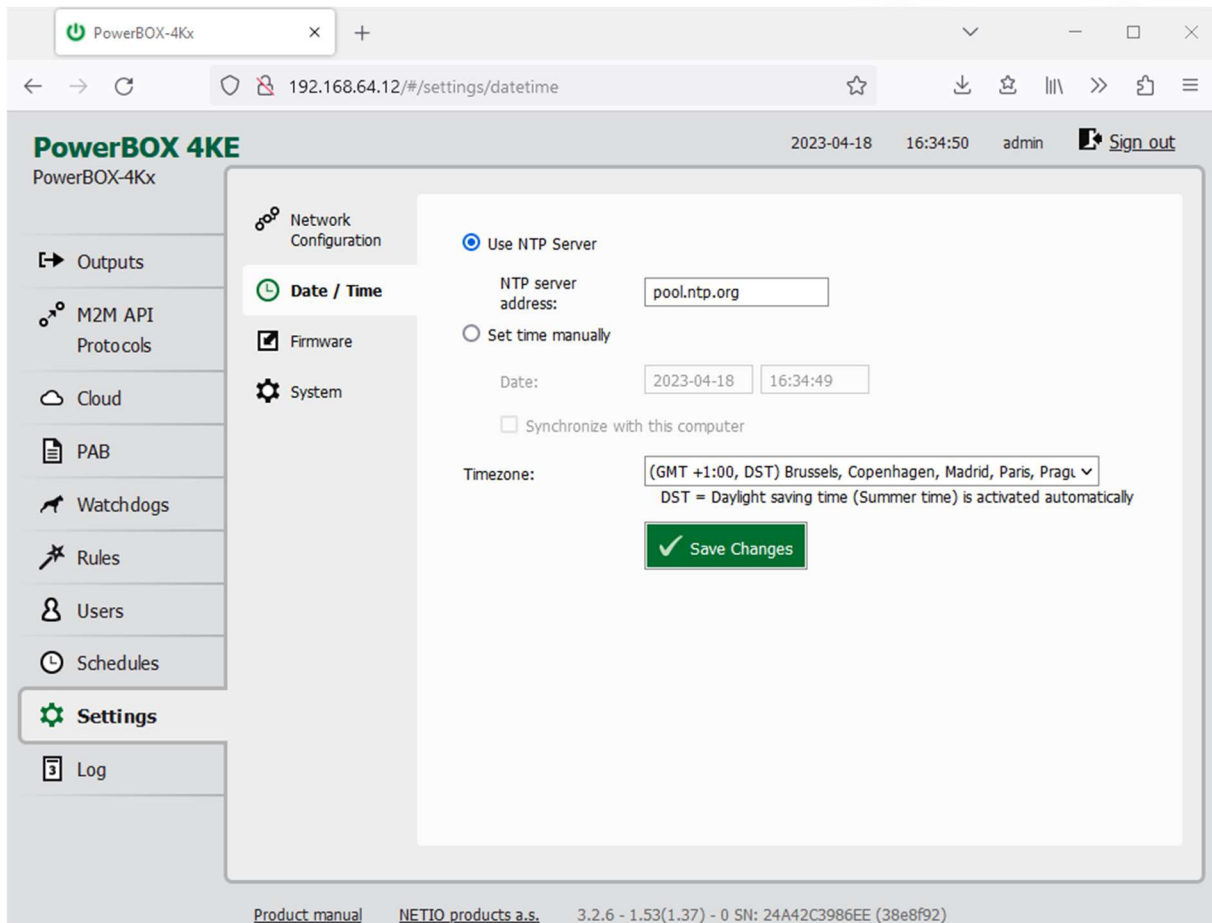

Figure 43 - Date / time settings

Use NTP server

When selected, the device's clock is periodically synchronized with a NTP server. If you do not have your own NTP server in your network, use e.g. tik.cesnet.cz

Set time manually

Select if you do not wish to use a NTP server.

Date

Current date and time on the NETIO device's clock. Can be modified if necessary.

Synchronize with this computer

Check this box to copy the current date and time from your computer to NETIO device's internal clock.

Timezone

Set the time zone to govern the time settings.

Save Changes

Saves the changes.

5.9.3 Firmware

The  **Firmware** section allows updating the firmware of your device. The current firmware version is shown in the footer of each page.

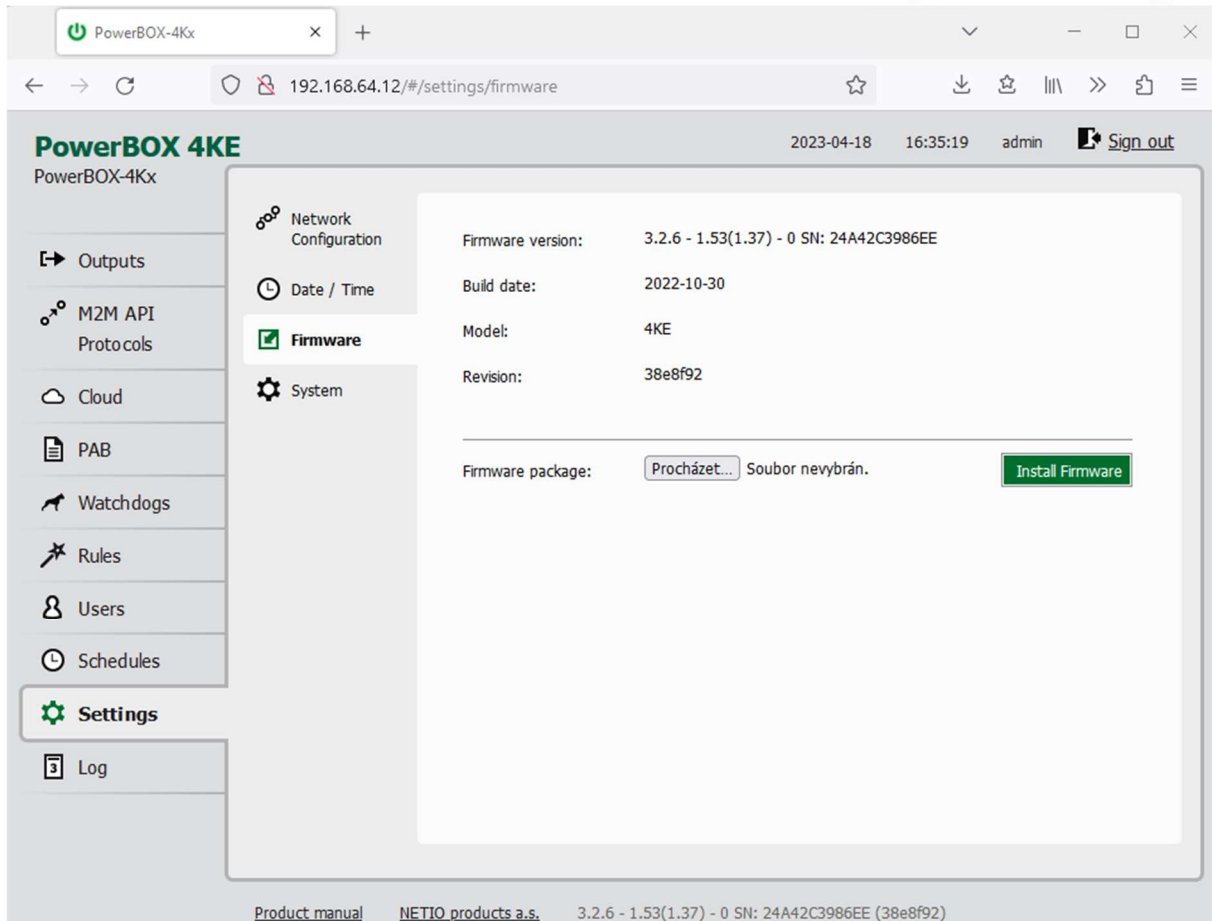

Figure 44 - Details about the installed firmware

Firmware version	Installed firmware version.
Build date	Creation date of the installed firmware version.
Model	Model designation.
Revision	Revision number.
Firmware Package	Click Browse to select a firmware file to install. Then click Install Firmware to start the installation.

Firmware files are available at: <https://www.netio-products.com/en/firmware-archive-netio>

Where to find the right fw?

Go to the product page on our website (link below), select your product and scroll down the page.

<https://www.netio-products.com/en/products/all-products>

The screenshot shows the product page for the NETIO PowerDIN 4PZ. The page includes navigation links for General properties, Technical specifications, FAQ, Download, Photo and video, Product comparison, and Available models. The main content area is divided into three sections: Flyer, Manual, and Quick Installation Guide. Each section has download buttons for English (EN), Czech (CS), and German (DE). Below these sections, there are links for Software and Applications for mobile. The 'Software' section includes a link for 'UDP-Discover v1.0.10 - Windows - EXE' and a link for 'Firmware PowerDIN 4PZ firmware', which is highlighted with a red box. The 'Applications for mobile' section includes a link for 'Android' and an image of a smartphone.

Figure 45 - WEB of NETIO products - Link to Firmware download



Caution

Before installing firmware, read carefully the instructions at our website, make sure that you are upgrading from the correct version, and follow the prescribed procedure.

Downgrade to a lower firmware version may cause the device to reset to factory defaults. This will disconnect the device from your Wi-Fi network. For this reason, we strongly discourage from downgrading the firmware remotely, without physical access to the device. Before downgrading the firmware, always consider if it is really necessary and if needed, contact technical support: support@netio.eu

5.9.4 System

This section allows performing basic settings and viewing basic parameters of the device.

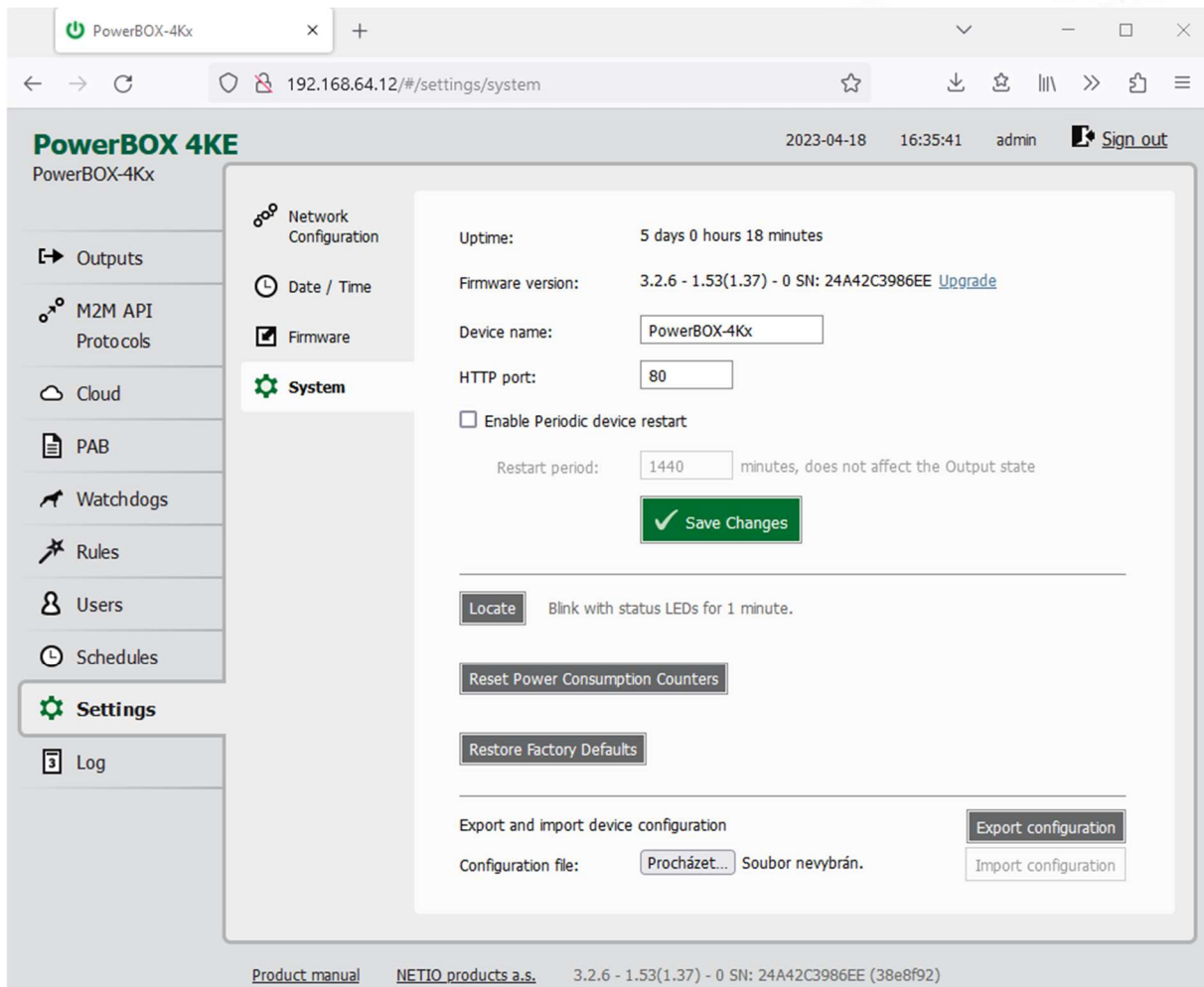



Figure 46 - System settings

Uptime	Time since the last restart of the device.
Firmware version	Currently installed firmware version and a link to the Firmware tab.
Device name	Shown in NETIO Discover and under the device logo in the web administration (in the figure above: <i>PowerBOX-4Kx</i> under the PowerBOX logo in the top left corner). The device “Hostname” is generated from this Device name (unsupported characters are replaced).
HTTP port	Current http port for webadministration and http based M2M API protocols (XML, JSON, URL API). If the port number is different from 80, it has to be specified in the web browser after the NETIO device IP address, e.g.: 192.168.0.99:888
Enable Periodic device restart	Enables automatic restarting of the device.

<i>Restart period</i>	Specifies the interval for automatic device restarts. The restart does not affect the state of the output.
<i>Debug Log</i>	Adds a DebugLog section with diagnostic values to XML and JSON M2M API.
<i>Save Changes</i>	Saves the changes.
<i>Locate</i>	Identifies a particular device. When clicked, the yellow LED no. 1 starts flashing with pauses.
<i>Reset Power Consumption Counter</i>	Resets the electricity consumption counters.
<i>Factory Reset Defaults</i>	Resets NETIO device to factory defaults. Follow section 4 to make the device operational again.
<i>Export and import device configuration</i>	<p>Can be used to back-up and restore device configuration. Do not modify the exported file!</p> <p>“Export configuration” - shows a confirmation dialog for exporting the device configuration and downloading it to your computer.</p> <p>“Browse” - opens a dialog to select a configuration file for import into the device.</p> <p>“Import configuration” - shows a confirmation dialog for importing the device configuration. After the import, the device restarts and the imported configuration takes effect.</p>

5.10 Log

In the left menu, select  **Log**.

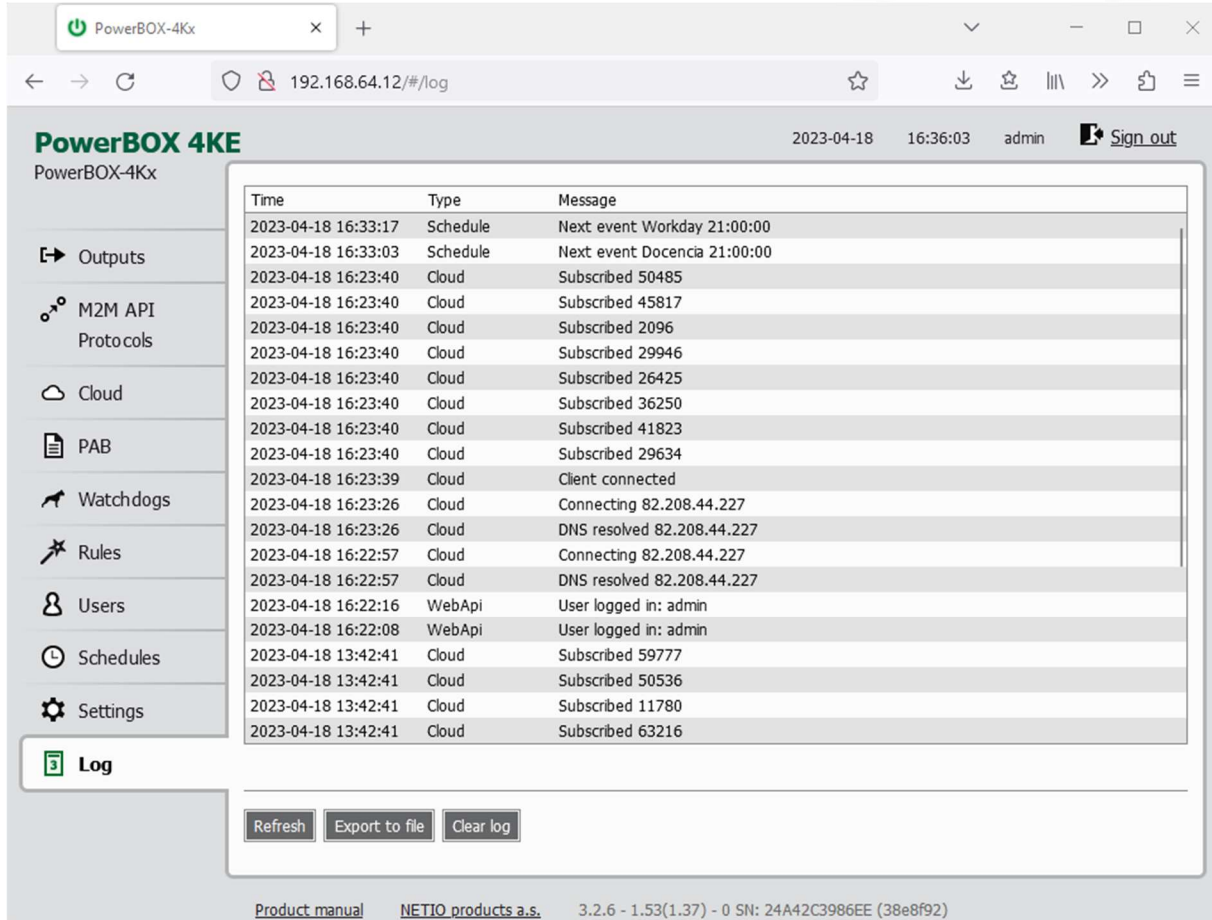

PowerBOX 4KE 2023-04-18 16:36:03 admin [Sign out](#)

Time	Type	Message
2023-04-18 16:33:17	Schedule	Next event Workday 21:00:00
2023-04-18 16:33:03	Schedule	Next event Docencia 21:00:00
2023-04-18 16:23:40	Cloud	Subscribed 50485
2023-04-18 16:23:40	Cloud	Subscribed 45817
2023-04-18 16:23:40	Cloud	Subscribed 2096
2023-04-18 16:23:40	Cloud	Subscribed 29946
2023-04-18 16:23:40	Cloud	Subscribed 26425
2023-04-18 16:23:40	Cloud	Subscribed 36250
2023-04-18 16:23:40	Cloud	Subscribed 41823
2023-04-18 16:23:40	Cloud	Subscribed 29634
2023-04-18 16:23:39	Cloud	Client connected
2023-04-18 16:23:26	Cloud	Connecting 82.208.44.227
2023-04-18 16:23:26	Cloud	DNS resolved 82.208.44.227
2023-04-18 16:22:57	Cloud	Connecting 82.208.44.227
2023-04-18 16:22:57	Cloud	DNS resolved 82.208.44.227
2023-04-18 16:22:16	WebApi	User logged in: admin
2023-04-18 16:22:08	WebApi	User logged in: admin
2023-04-18 13:42:41	Cloud	Subscribed 59777
2023-04-18 13:42:41	Cloud	Subscribed 50536
2023-04-18 13:42:41	Cloud	Subscribed 11780
2023-04-18 13:42:41	Cloud	Subscribed 63216

Refresh Export to file Clear log

Product manual NETIO products a.s. 3.2.6 - 1.53(1.37) - 0 SN: 24A42C3986EE (38e8f92)

Figure 47 - Event log

Refresh Reloads the log to show the most recent entries.

Export to file Exports the log in the html format.

Clear log Clears the log records.

The log contains 40 most recent events only and is cleared when the device is restarted.

Sources (types) of log entries:

System	Event generated by the system itself, e.g. WiFi reconnect
WebApi	Event related to a request from the web interface, e.g. User logged in
XML	M2M XML protocol
JSON	M2M JSON protocol
M2M URL	M2M URL API protocol
Modbus	M2M Modbus/TCP protocol
MQTT	M2M MQTT protocol
SNMP	M2M SNMP protocol
Web server	Web server, e.g. Client disconnected
Cloud	NETIO Cloud

6 DECLARATION OF CONFORMITY

Manufacturer: NETIO products a.s.
U Pily 3/103
143 00 Praha 4, Czech Republic

Address:

Product: NETIO PowerBOX 3PE
NETIO PowerBOX 3PF
NETIO PowerBOX 3PG

This declaration of conformity is issued under the sole responsibility of the manufacturer.

Object of the declaration: "NETIO PowerBOX 3Px controlled and monitored over the LAN network".

RTTED:

The product mentioned above to which this declaration relates is in conformity with the essential requirements and other relevant requirements of the **R&TTE Directive (1999/5/EC)**.

LVD:

The product mentioned above to which this declaration relates is in conformity with the essential requirements and other relevant requirements of the **Directive 2006/95/EC**.

The product mentioned above is in conformity with the following standards and/or other normative documents:

EN 60950-1

EN 62368

RoHS:

The product mentioned above to which this declaration relates is in conformity with the essential requirements and other relevant requirements of the **Directive 2011/65/EU** (restriction of the use of certain hazardous substances in electrical and electronic equipment).

The product mentioned above is in conformity with the following standards and/or other normative documents:

EN 50581: 2012

Czech Republic, Prague, February 26th, 2020

Jan Řehák, Chief of the board



DECLARATION OF CONFORMITY

Manufacturer: NETIO products a.s.
Address: U Pily 3/103
143 00 Praha 4, Czech Republic
Product: NETIO PowerBOX 4KE
NETIO PowerBOX 4KF
NETIO PowerBOX 4KG

This declaration of conformity is issued under the sole responsibility of the manufacturer.

Object of the declaration: "NETIO PowerBOX 4Kx controlled and monitored over the LAN network".

RTTED:

The product mentioned above to which this declaration relates is in conformity with the essential requirements and other relevant requirements of the **R&TTE Directive (1999/5/EC)**.

LVD:

The product mentioned above to which this declaration relates is in conformity with the essential requirements and other relevant requirements of the **Directive 2006/95/EC**.

The product mentioned above is in conformity with the following standards and/or other normative documents:

EN 60950-1

EN 62368

RoHS:

The product mentioned above to which this declaration relates is in conformity with the essential requirements and other relevant requirements of the **Directive 2011/65/EU** (restriction of the use of certain hazardous substances in electrical and electronic equipment).

The product mentioned above is in conformity with the following standards and/or other normative documents:

EN 50581: 2012

Czech Republic, Prague, January 29th, 2021

Jan Řehák, Chief of the board



7 Products overview

	LAN (RJ45)	WiFi / Ant.	Power Input / Output Type	Switched outputs	Metered outputs	DI Inputs	Power	Button(s) / Output LED(s)	Industrial features	Power-Up state
PowerPDU 4C (Linux)	2x	-	C14 / C13	4	4	RS232	110/230V / 10A	4 / 4	ZCS, RS232	Yes
PowerPDU 4KS	1	-	C14 / C13	4	4	1x (S0)	110/230V / 10A	1 / 4	ZCS	Yes
PowerPDU 4PS	1	-	C14 / C13	4	-	-	110/230V / 10A	1 / 4	ZVS	Yes
PowerPDU 8QS	1	-	C20 / C13	8	1 + all	1x (S0)	110/230V / 16A	1 / 0	ZVS	Yes
PowerDIN 4PZ	1	Int.	Terminal block	4	2	2x (S0)	110/230V / 16A	1 / 1	ZCS	Yes
PowerBOX 3PF	1	-	DE	3	-	-	230V / 16A	1 / 0	ZVS	Yes
PowerBOX 3PE	1	-	FR	3	-	-	230V / 16A	1 / 0	ZVS	Yes
PowerBOX 3PG	1	-	UK	3	-	-	230V / 13A	1 / 0	ZVS	Yes
PowerBOX 4KF	1	-	DE	4	4	-	230V / 16A	1 / 0	ZCS	Yes
PowerBOX 4KE	1	-	FR	4	4	-	230V / 16A	1 / 0	ZCS	Yes
PowerBOX 4KG	1	-	UK	4	4	-	230V / 13A	1 / 0	ZCS	Yes
PowerCable REST 101F	-	Int.	DE	1	1	-	230V / 16A	1 / 1	ZCS	Yes
PowerCable REST 101E	-	Int.	FR	1	1	-	230V / 16A	1 / 1	ZCS	Yes
PowerCable REST 101J	-	Int.	CH	1	1	-	230V / 10A	1 / 1	ZCS	Yes
PowerCable REST 101G	-	Int.	UK	1	1	-	230V / 13A	1 / 1	ZCS	Yes
PowerCable REST 101S	-	Int.	C14 / C13	1	1	-	110/230V / 10A	1 / 1	ZCS	Yes
PowerCable REST 101Y	-	Int.	(EU plug) / C13	1	1	-	230V / 10A	1 / 1	ZCS	Yes
PowerCable 2PZ	1	Int.	Terminal block	2	-	-	110/230V / 16A	1 / 0	ZVS	Yes
PowerCable 2KZ	1	Int.	Terminal block	2	2	2x (S0)	110/230V / 16A	1 / 0	ZCS	Yes

8 Product features

	Web	HTTPs	Scheduler function	Watchdog function	Local scripting	Telnet	Modbus/TCP	XML	JSON	URL-API	SNMP v1	SNMP v3	Http(s) push XML / JSON	MQTT	MQTT-flex
PowerPDU 4C (Linux)	Yes	Yes	Yes	Ping only	Lua	Yes	Yes	Yes	Yes	Yes	Yes	Yes	-	Yes	-
PowerPDU 4KS	Yes	-	Yes	Ping + Power	C&R	Yes	Yes	Yes	Yes	Yes	Yes	Yes	Yes	-	Yes
PowerPDU 4PS	Yes	-	Yes	Ping	C&R	Yes	Yes	Yes	Yes	Yes	Yes	Yes	Yes	-	Yes
PowerPDU 8QS	Yes	-	Yes	Ping + Power	C&R	Yes	Yes	Yes	Yes	Yes	Yes	Yes	Yes	-	Yes
PowerDIN 4PZ	Yes	-	Yes	Ping + Power	C&R	Yes	Yes	Yes	Yes	Yes	Yes	Yes	Yes	-	Yes
PowerBOX 3Px (E,F,G)	Yes	-	Yes	Ping	C&R	Yes	Yes	Yes	Yes	Yes	Yes	Yes	Yes	-	Yes
PowerBOX 4Kx (E,F,G)	Yes	-	Yes	Ping + Power	C&R	Yes	Yes	Yes	Yes	Yes	Yes	Yes	Yes	-	Yes
PowerCable REST 101x	Yes	-	Yes	Ping + Power	C&R	Yes	Yes	Yes	Yes	Yes	Yes	Yes	Yes	-	Yes
PowerCable 2PZ	Yes	-	Yes	Ping + Power	C&R	Yes	Yes	Yes	Yes	Yes	Yes	Yes	Yes	-	Yes
PowerCable 2KZ	Yes	-	Yes	Ping + Power	C&R	Yes	Yes	Yes	Yes	Yes	Yes	Yes	Yes	-	Yes

C&R = Conditions & Rules